

Princeton University Library



32101 073505271



زَيْنُ الْمَحْتَمَلِ

مرآة الميقات والادوار

تأليف

الغازي أحمد مختار پاشا

Ahmed Mukhtar pasha, Ghazi

طبع بمطبعة خيسري فندي الرسام بحروف مستقيمة

في ١٣٠٣ هـ

4

Bozomo

شكلا

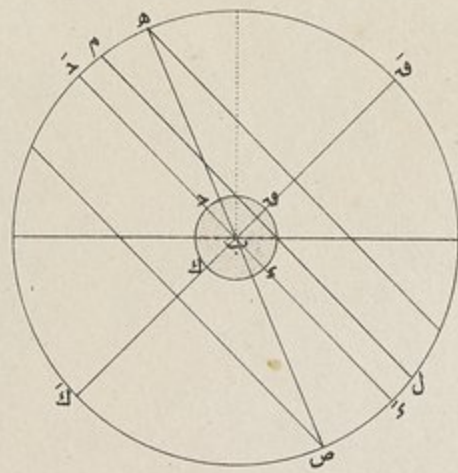

شكلا

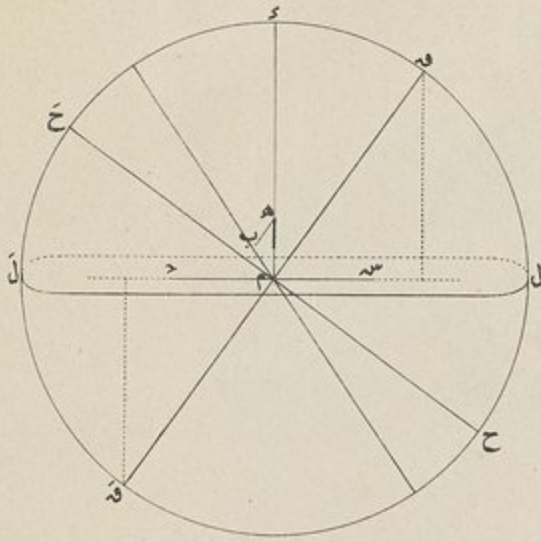

شكلا

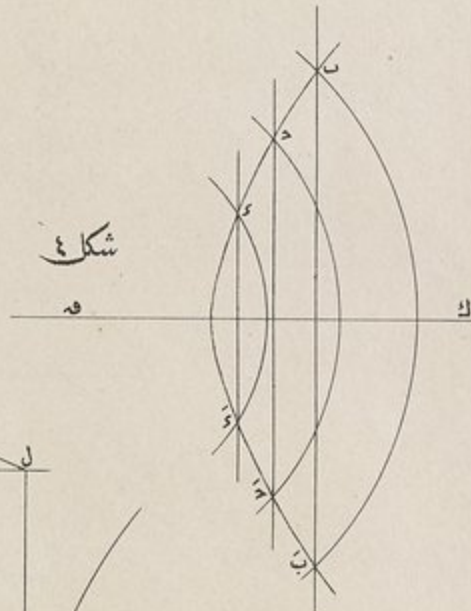

شكلا

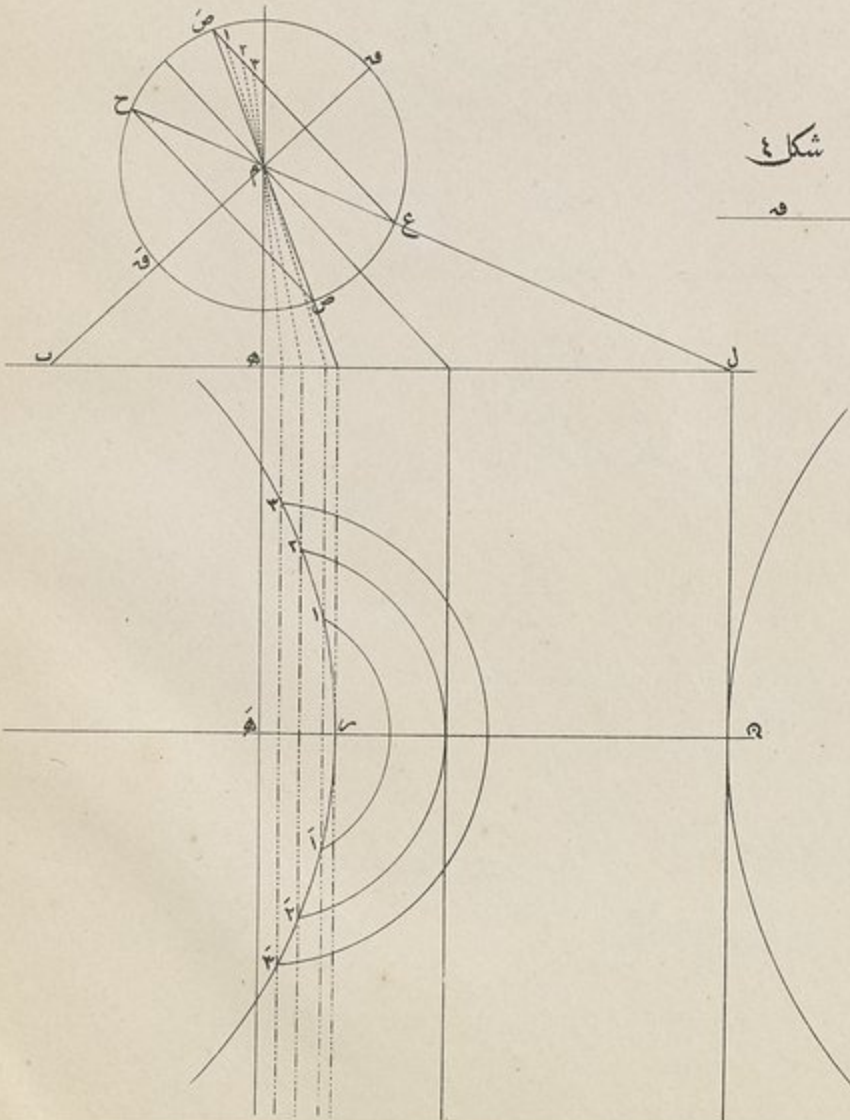

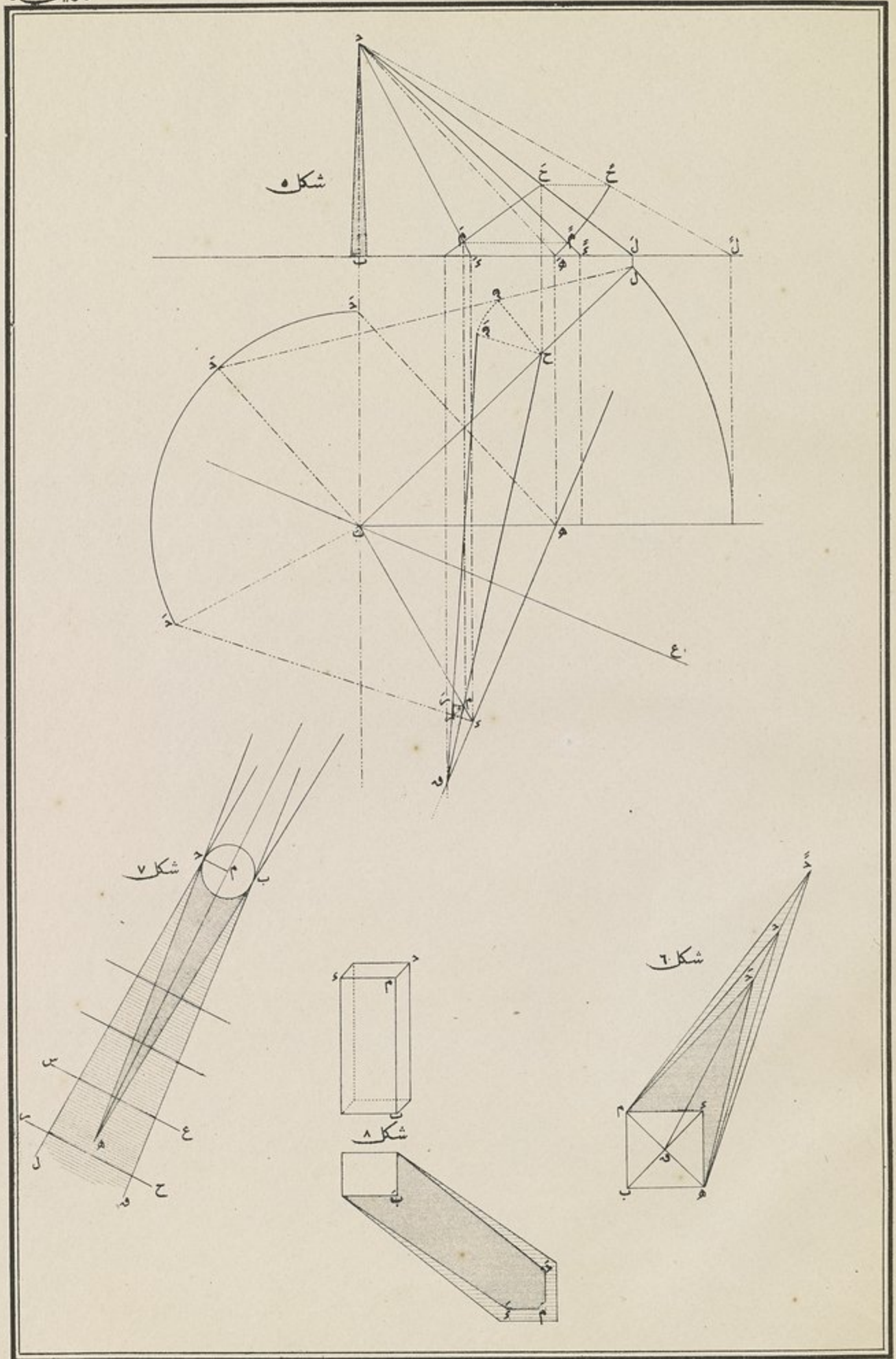

SBF Koenig's Curator

(RECAP)
 2070
 1173
 1377
 .99 plates

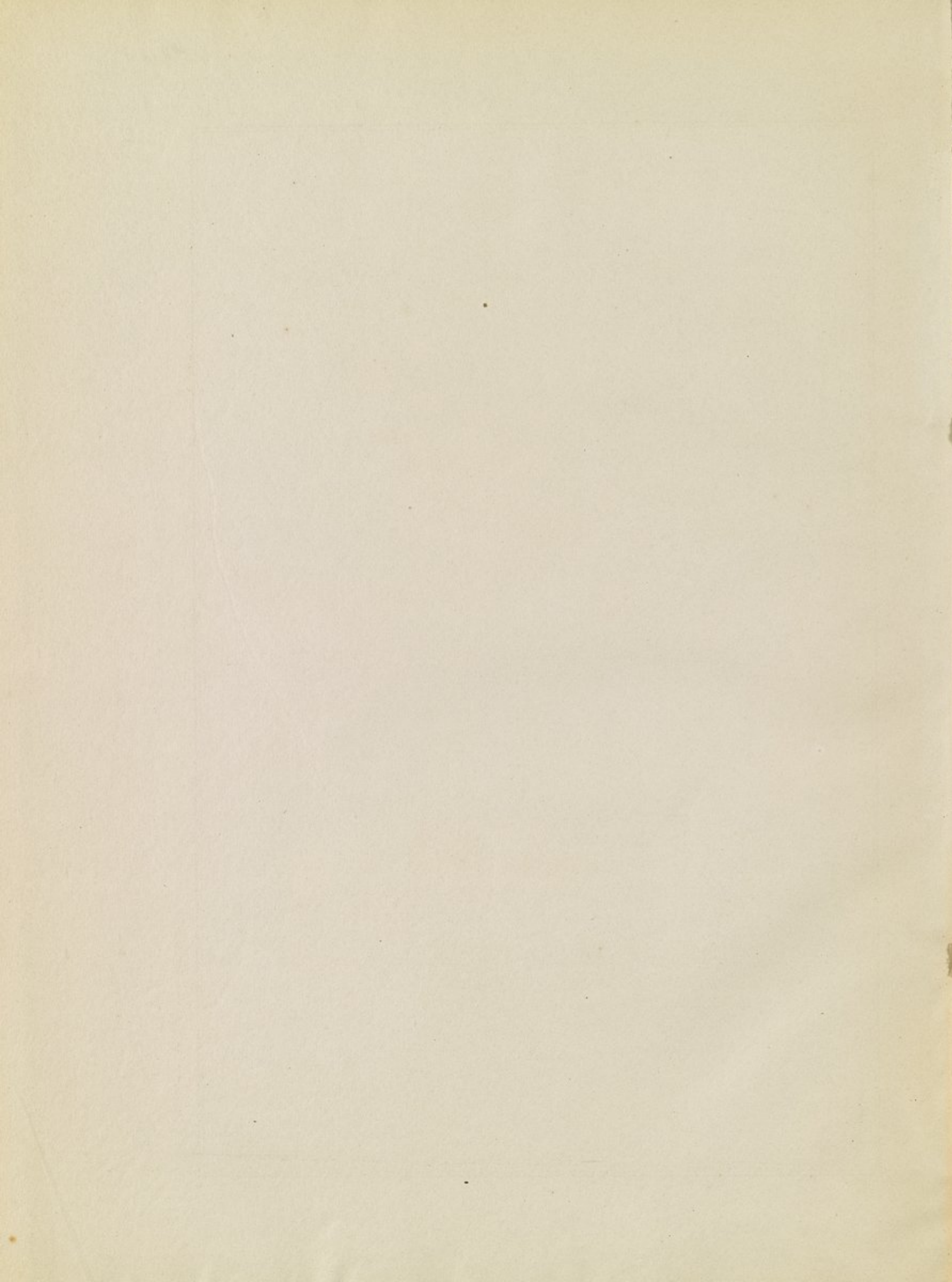

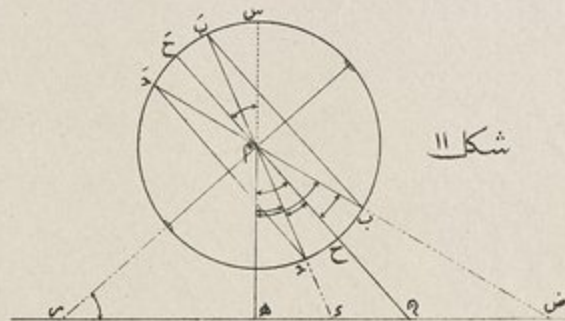
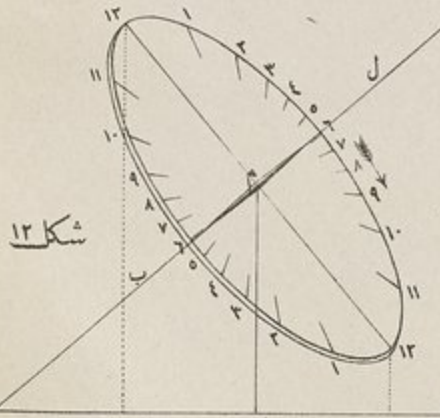
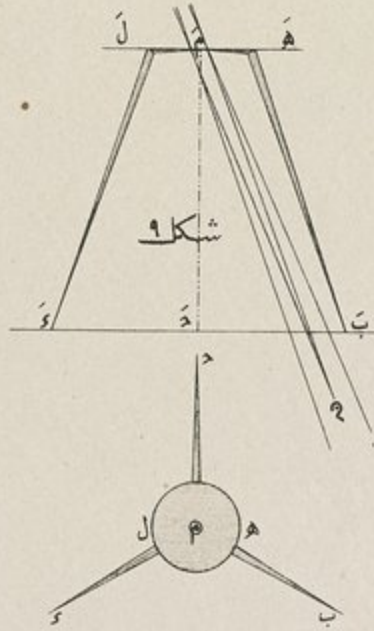
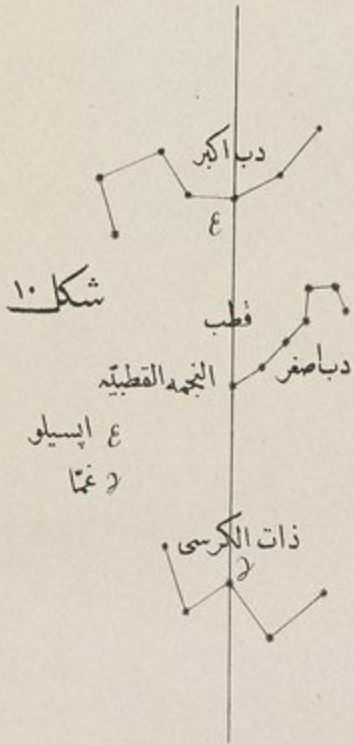

شكل ١٣

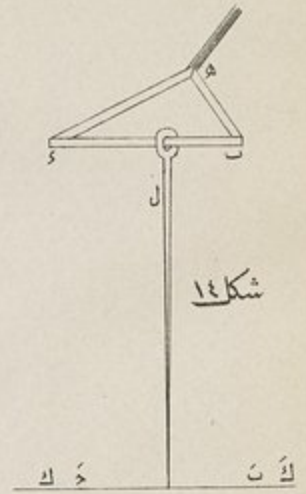
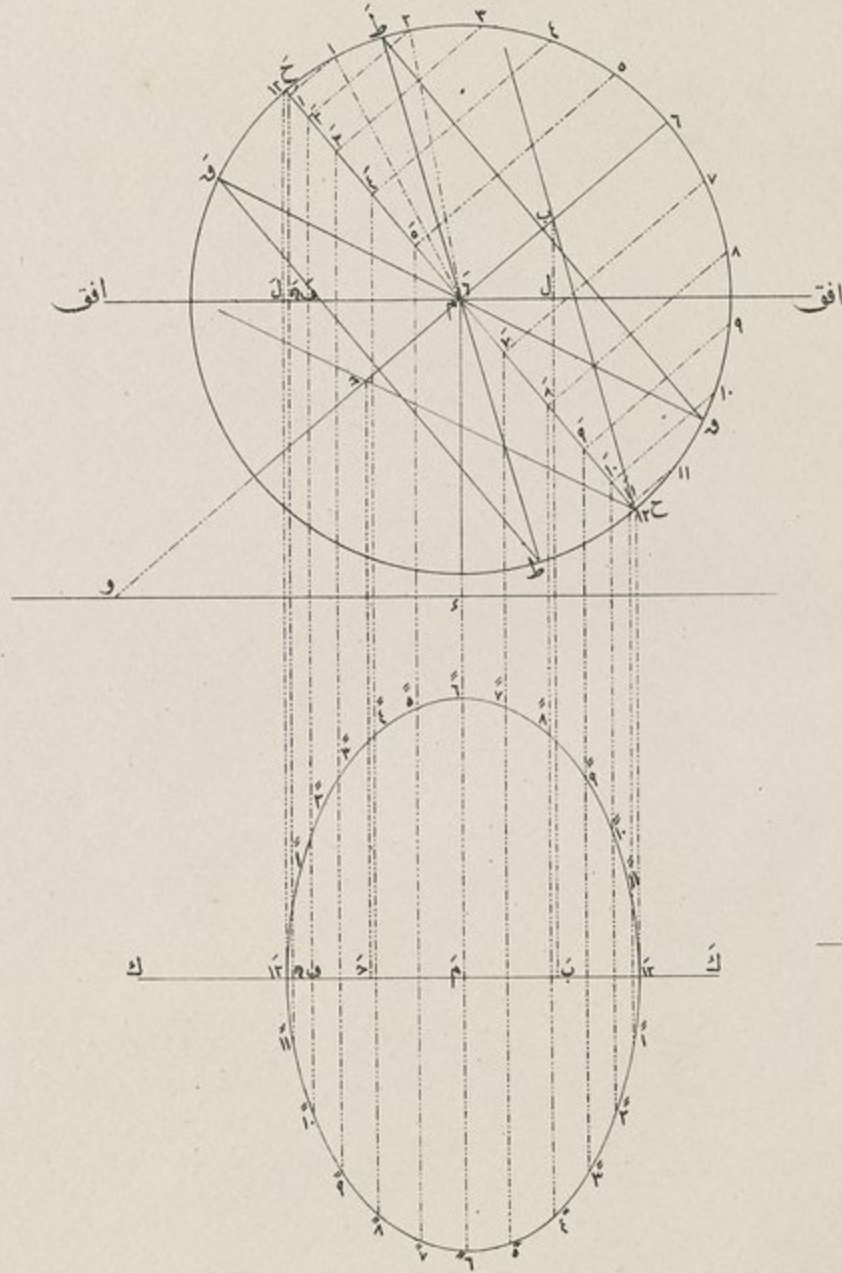

شكل ١٤

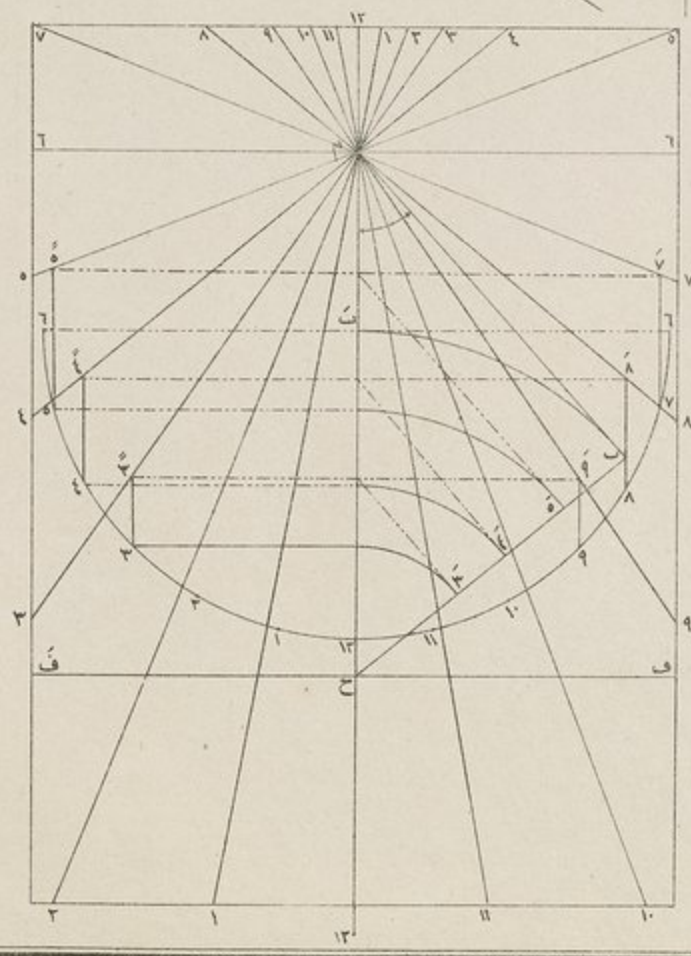
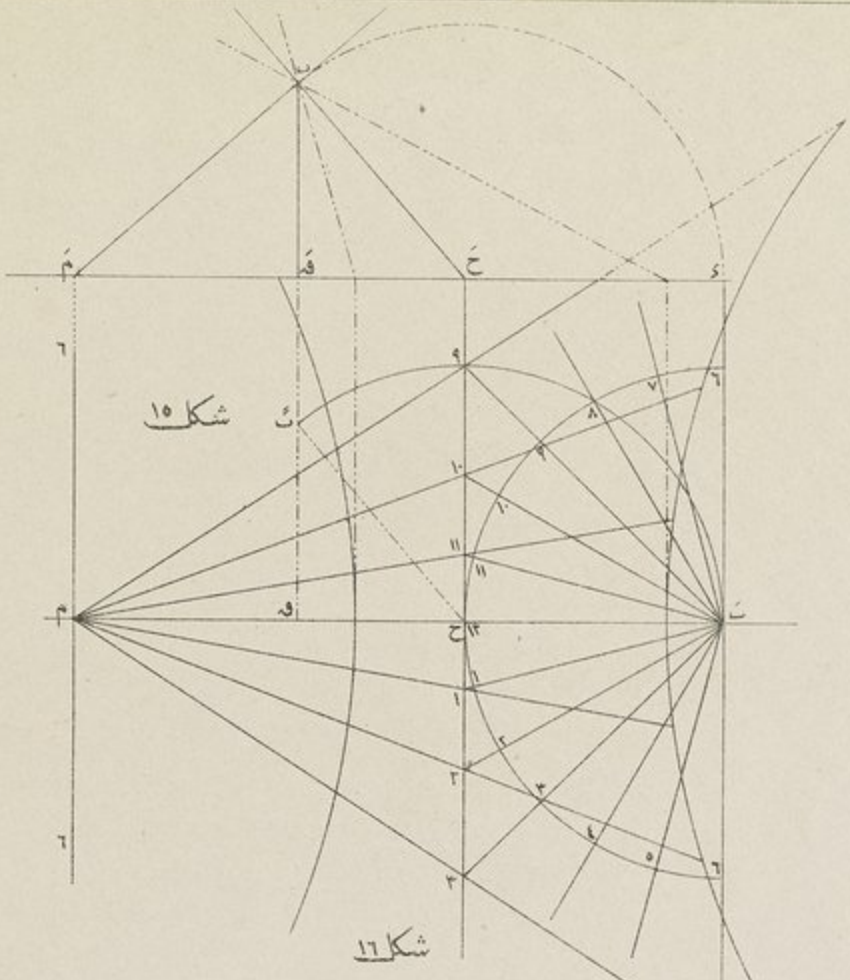

شکل ١٧

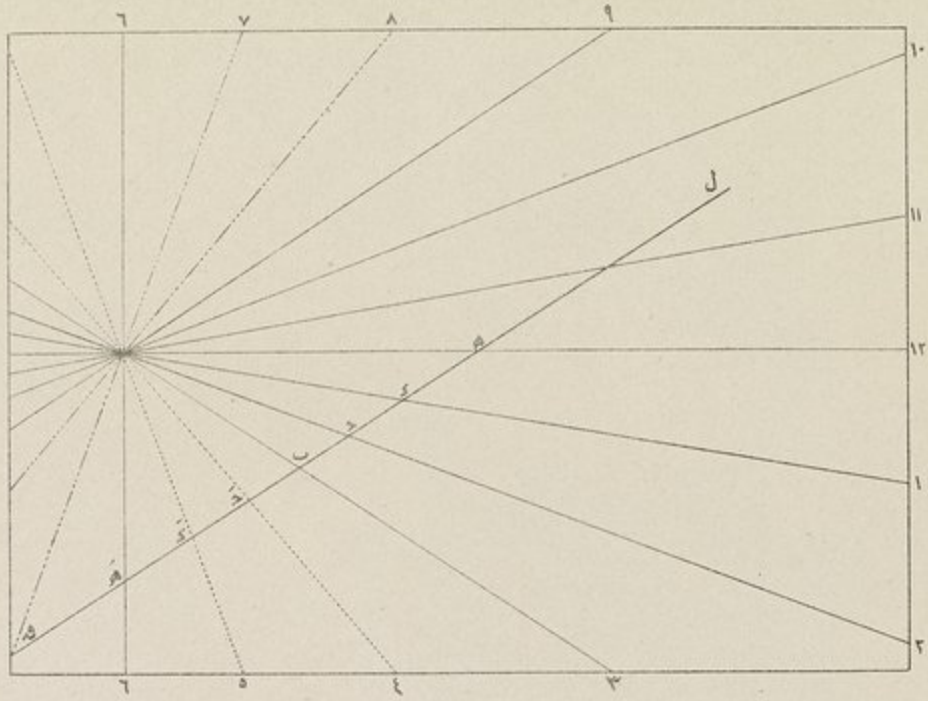

شکل ١٨

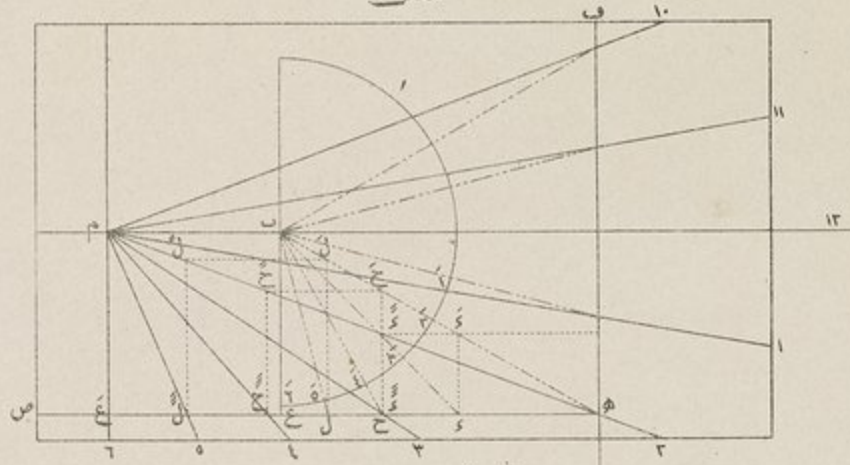

شکل ١٩

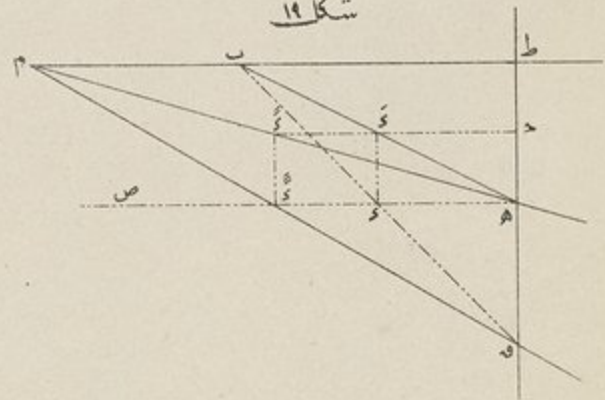

شکل ٢٠

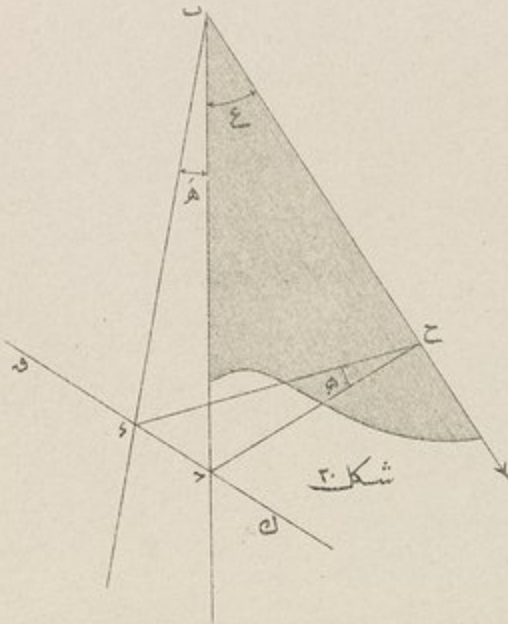

شكل ٢١

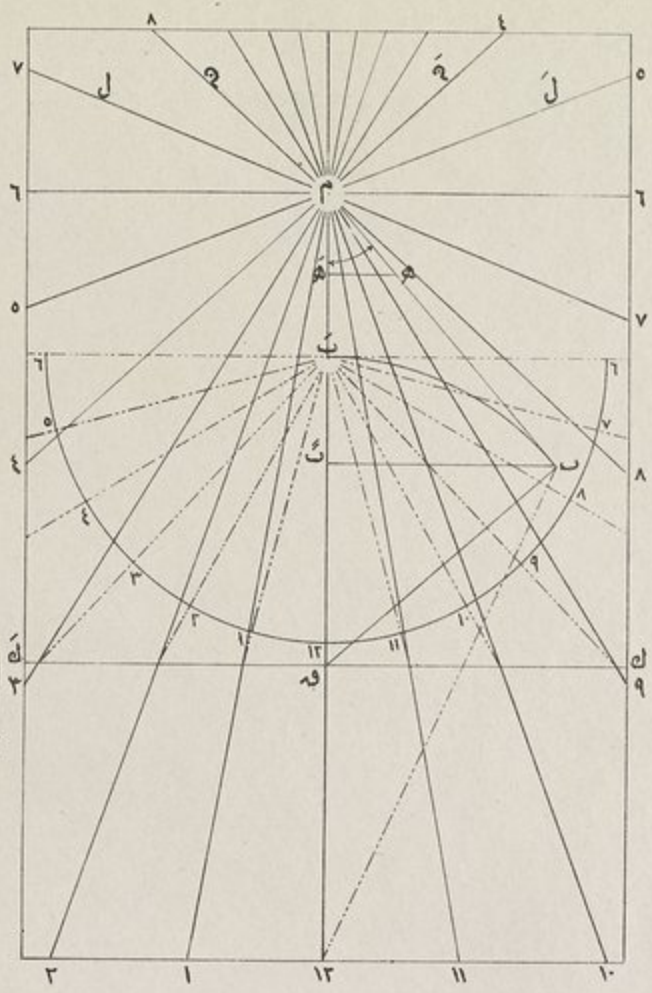

شكل ٢٢

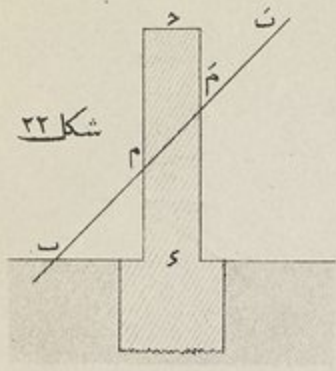

شكل ٢٣

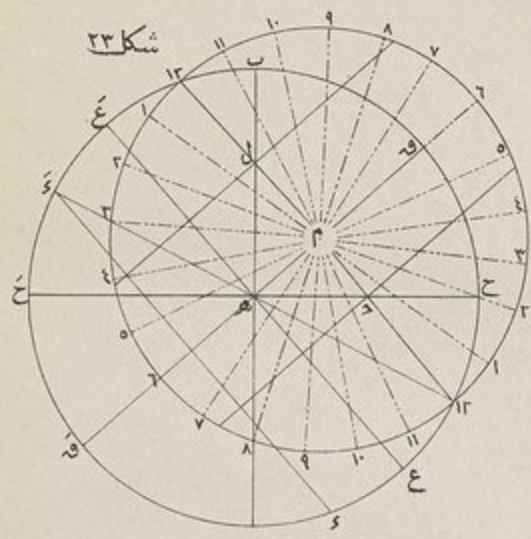

شكل ٢٥

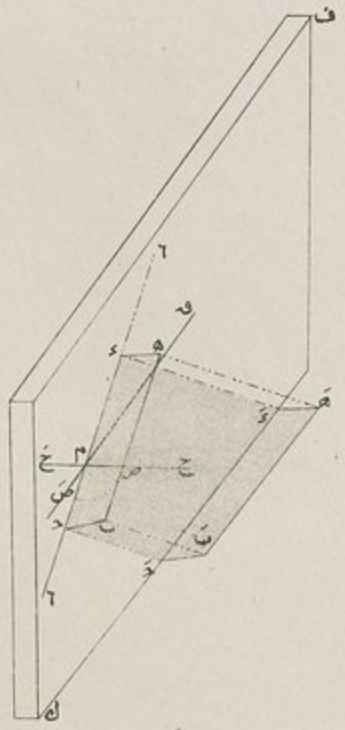

شكل ٢٤

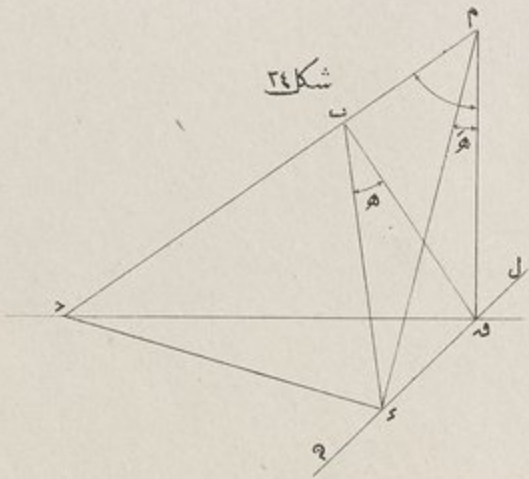

شكل ٢٦

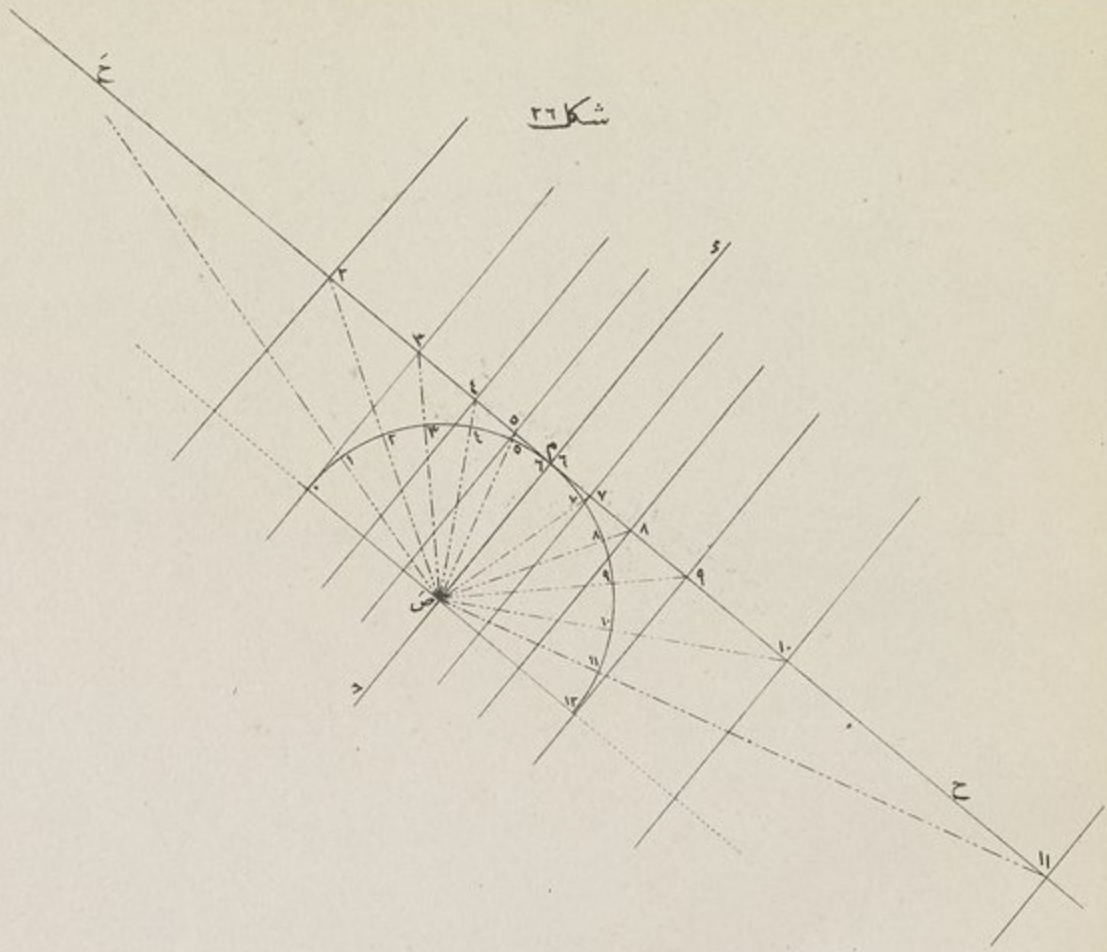

شكل ٢٧

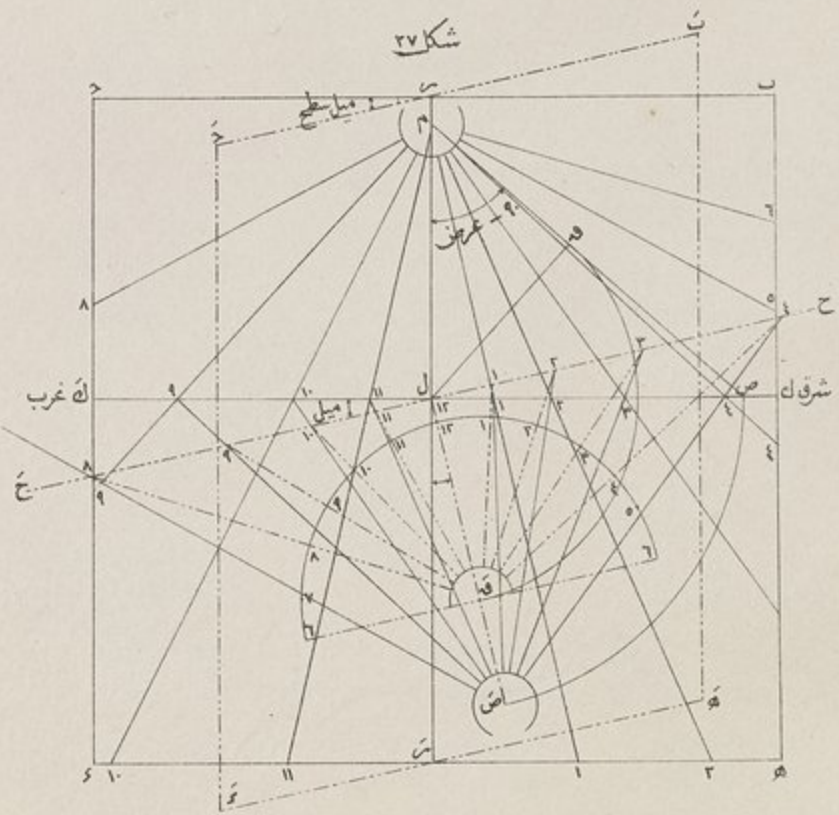

شكل ٢٨

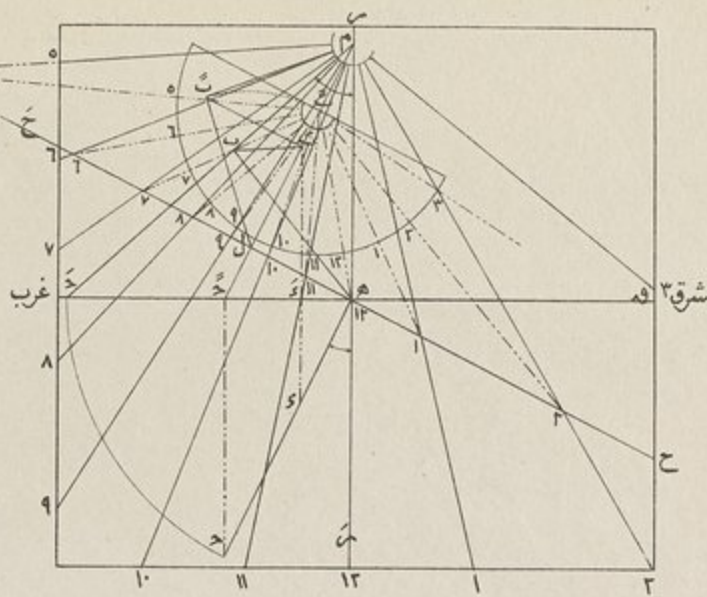

شكل ٢٩

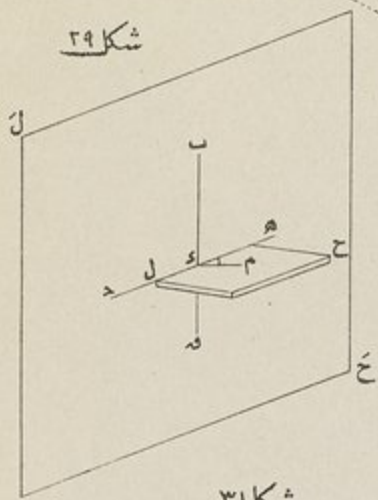

شكل ٣١

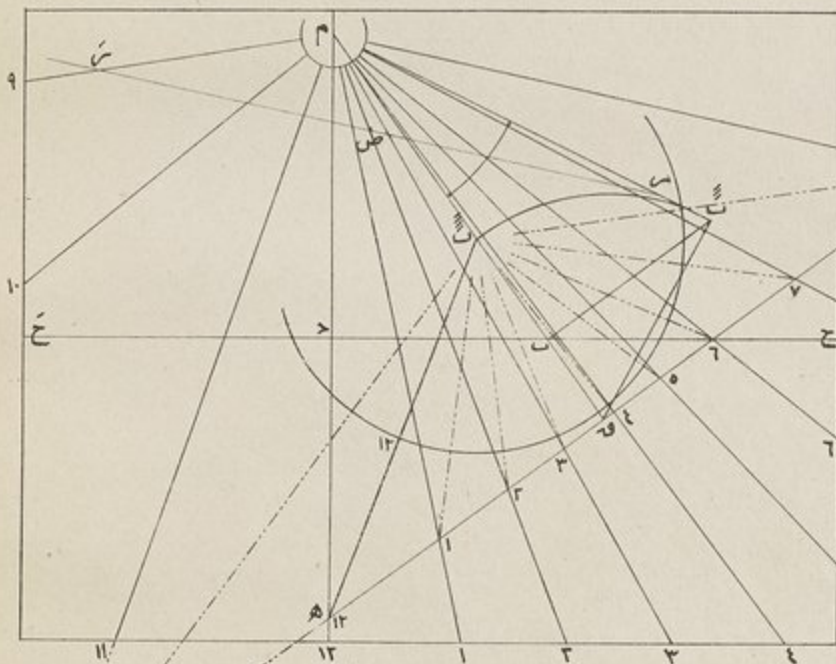

شكل ٣٢

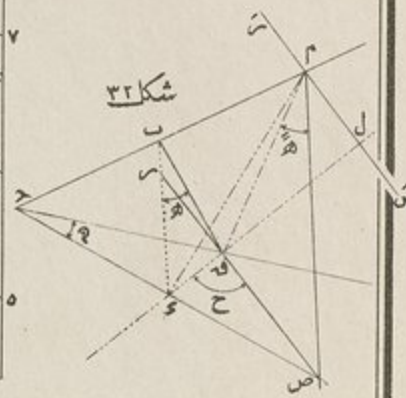

شكل ٣٣

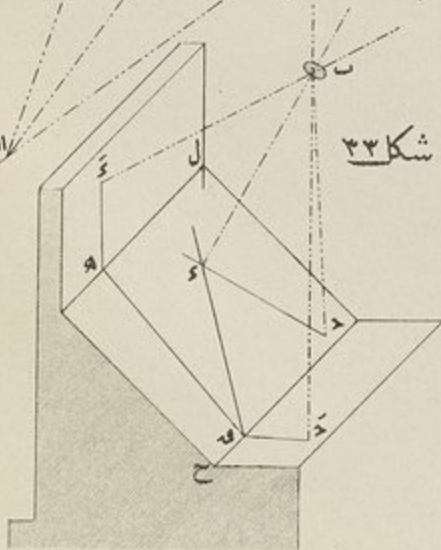

شكل ٣٠

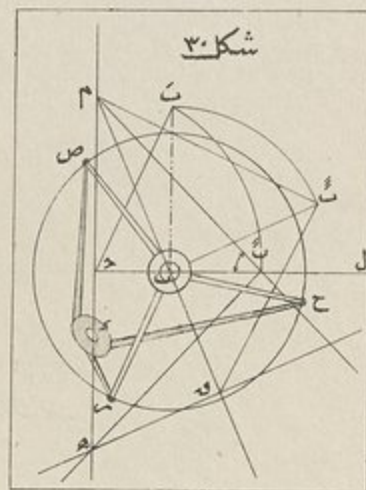

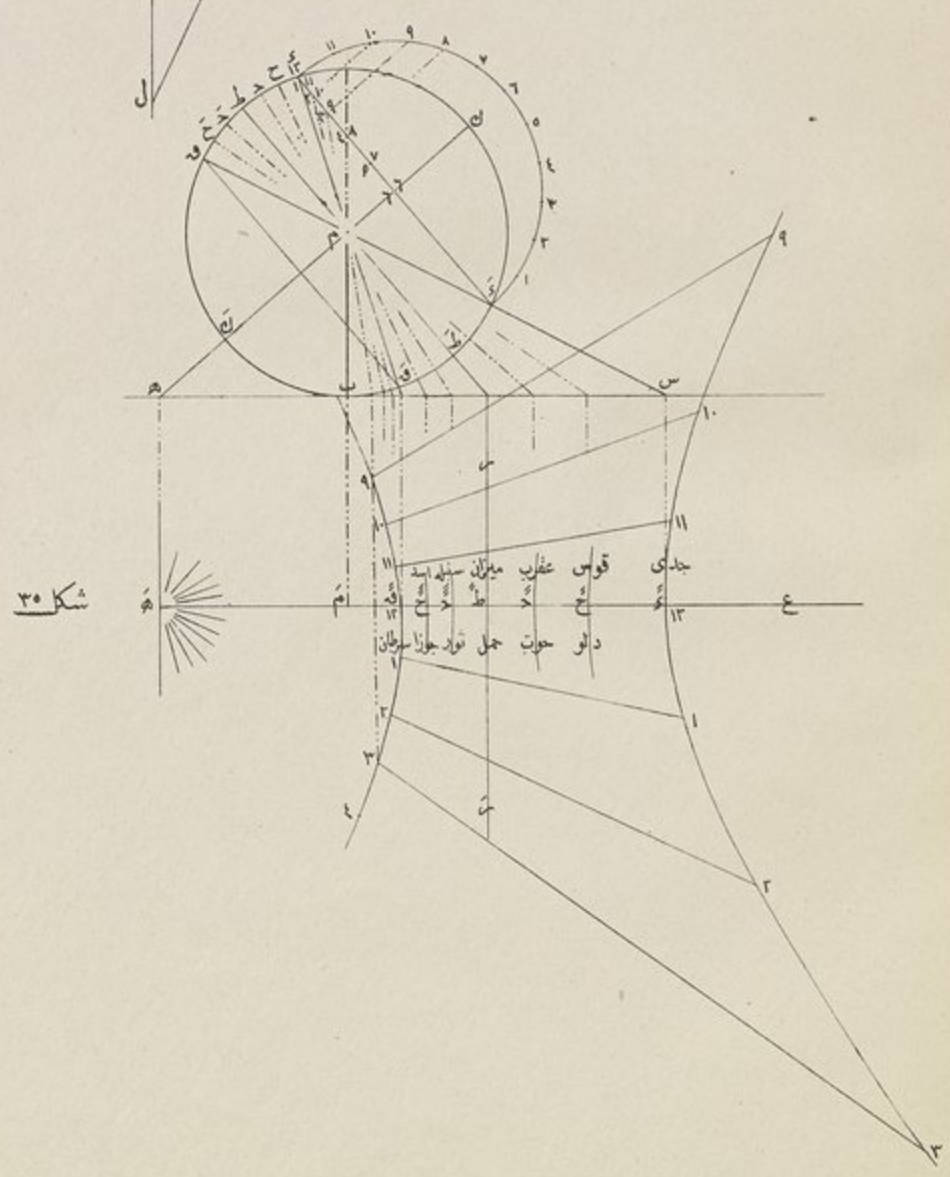
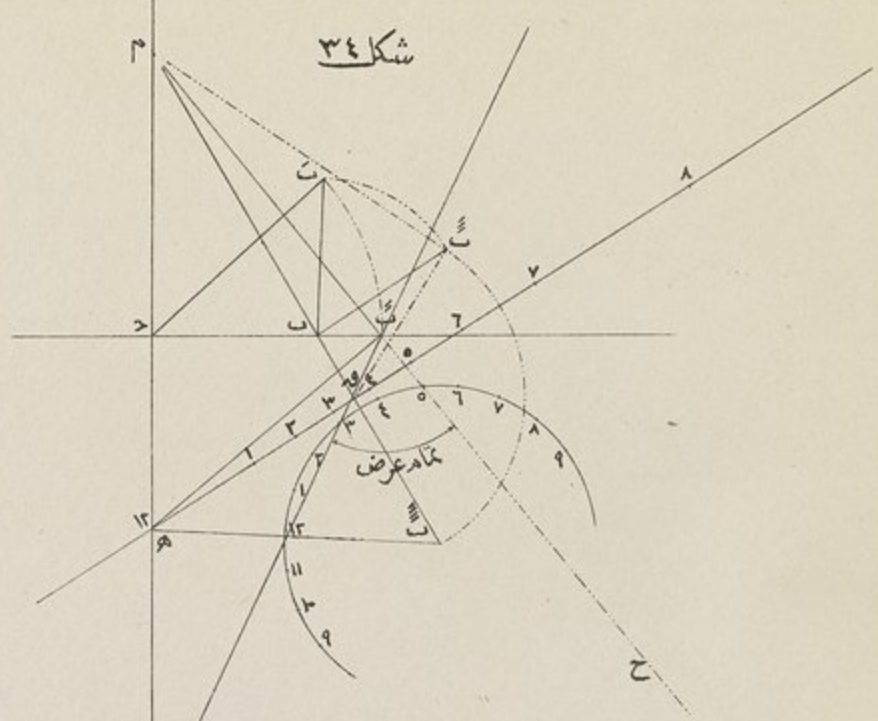

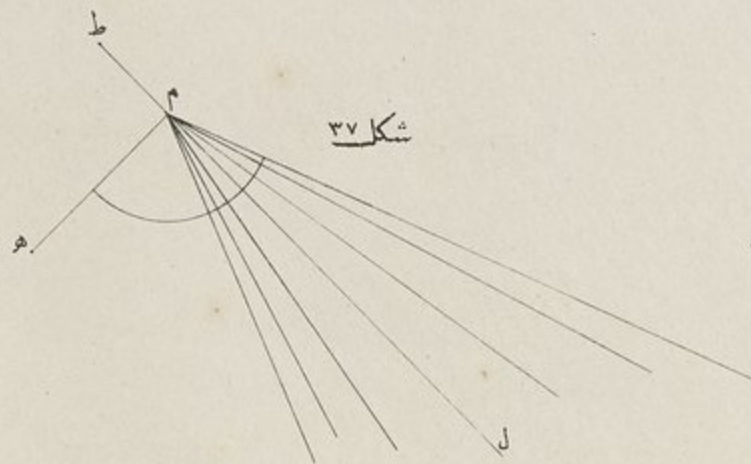
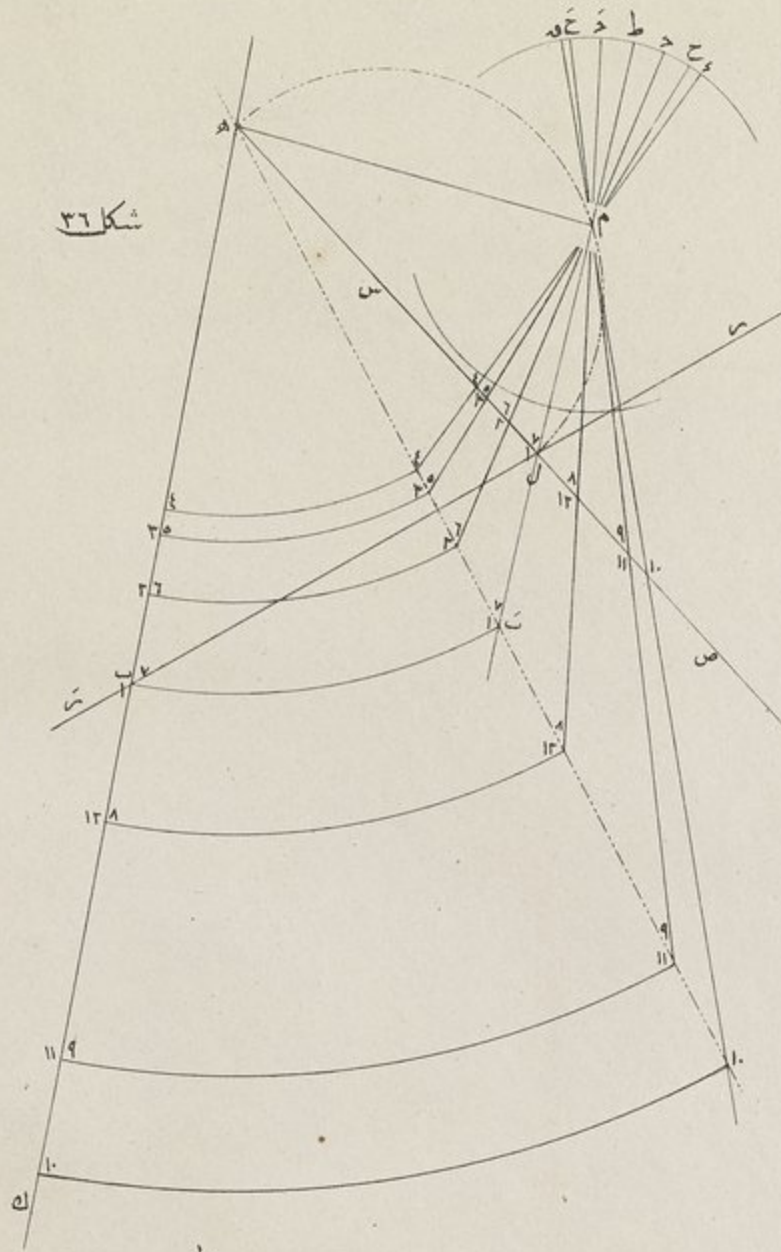

شكل ٣٩

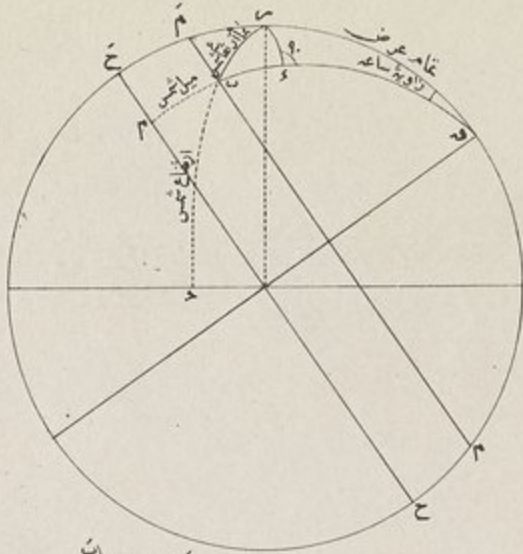

شكل ٣٨

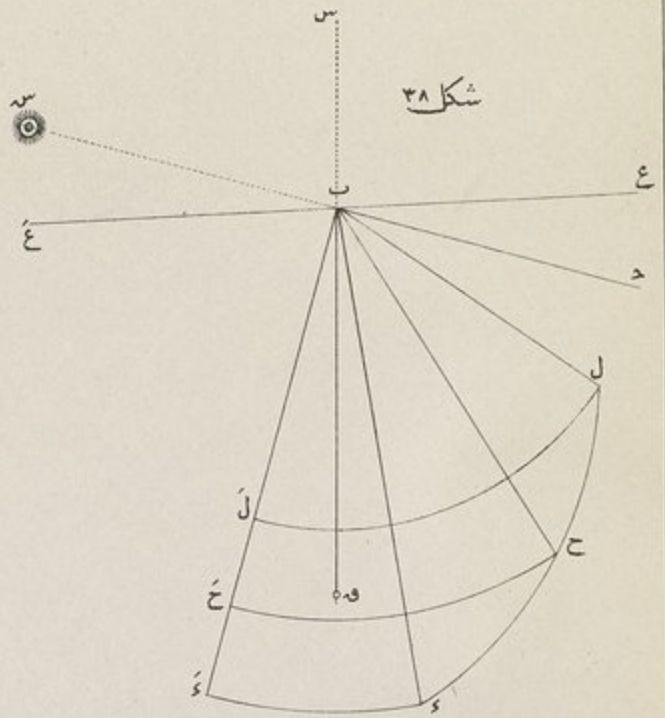

شكل ٤٢

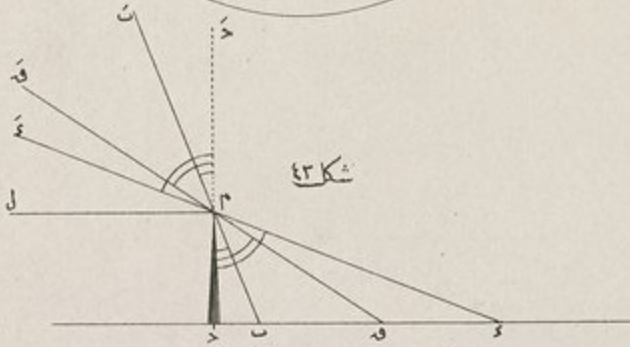

شكل ٤٤

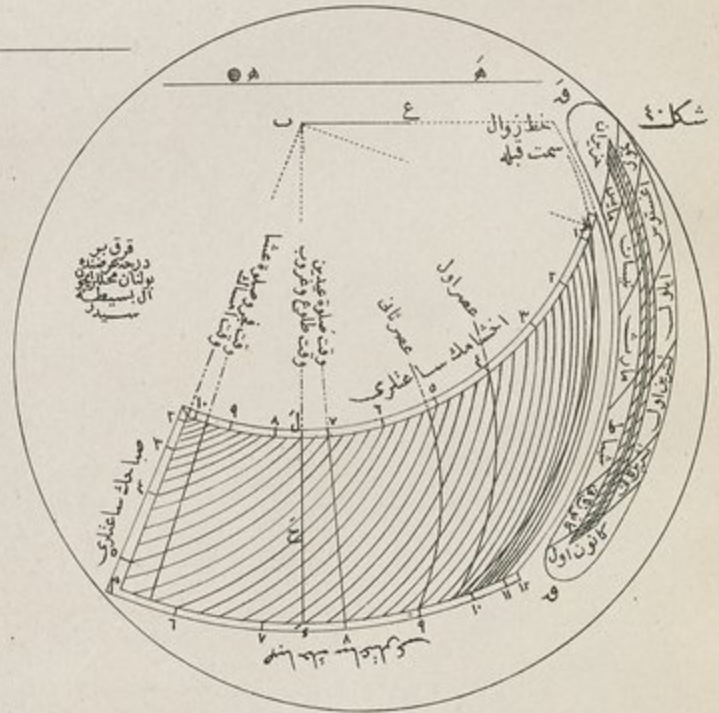

شكل ٤٣

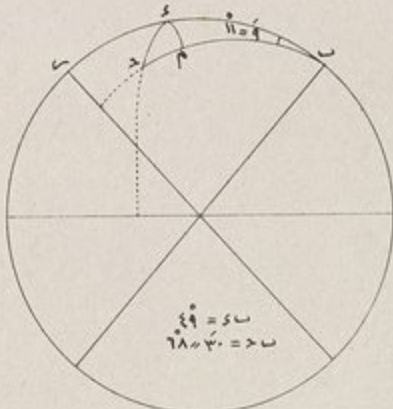

شكل ٤٥

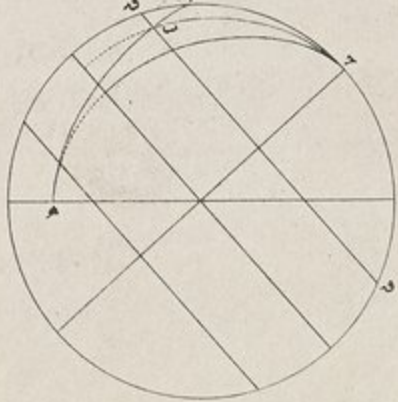

شكل ٤٤

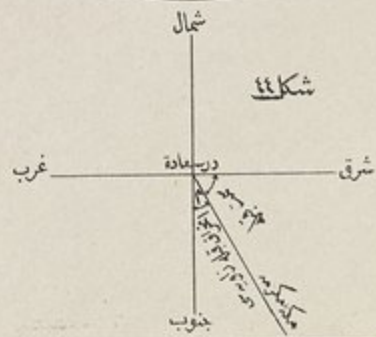

$س = ٤٩$
 $ط = ٦٨$

شكل ٤٦

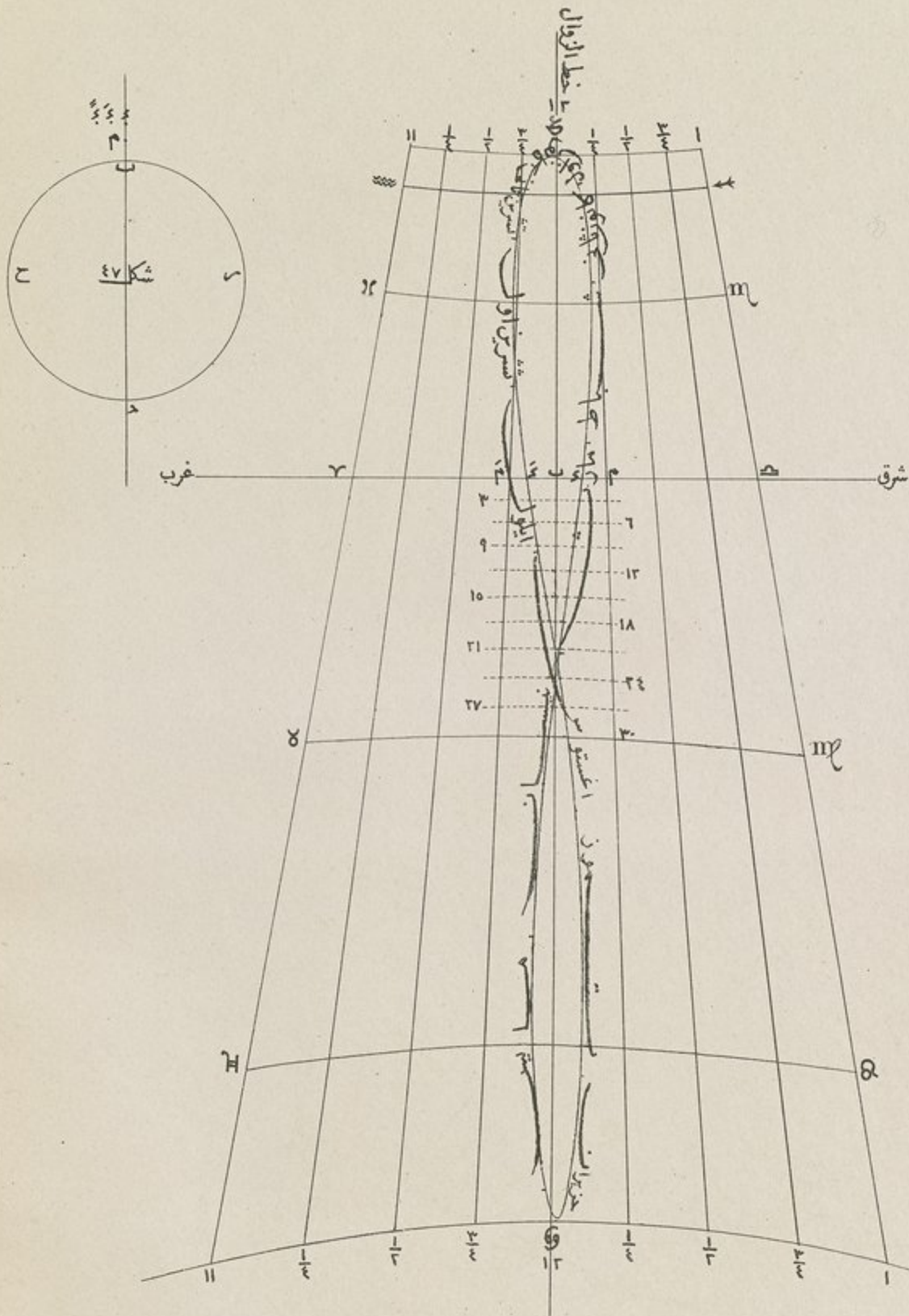

شكلا ٤٩

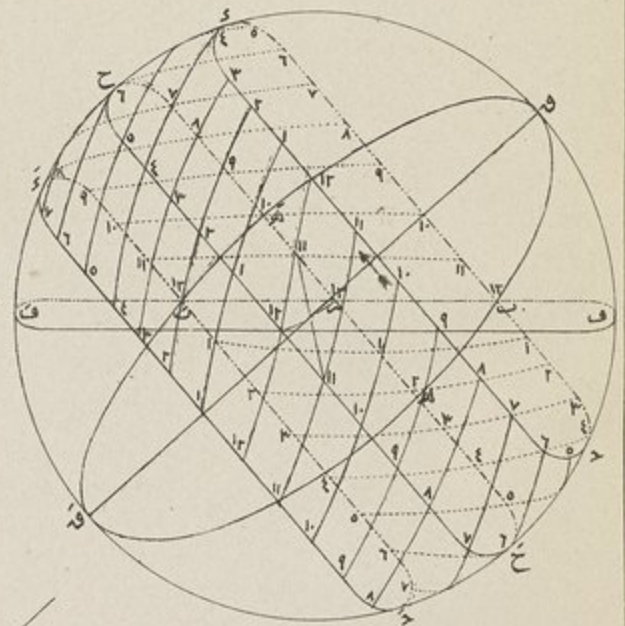

شكلا ٤٨

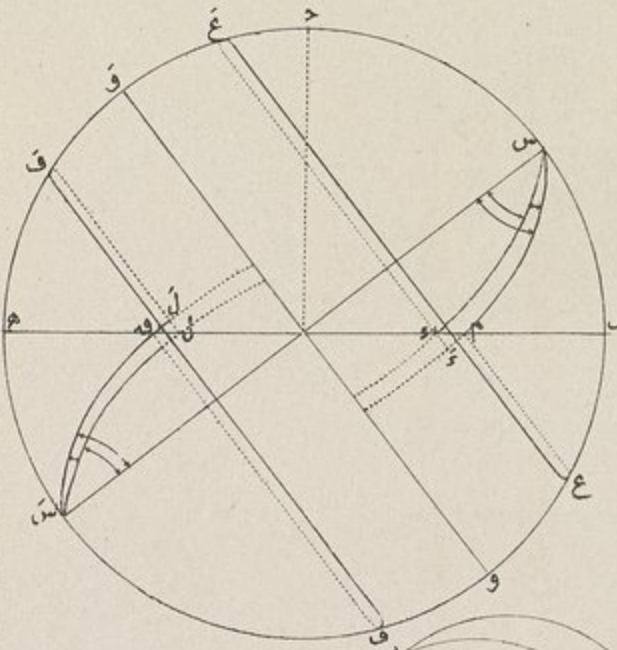

شكلا ٥٠

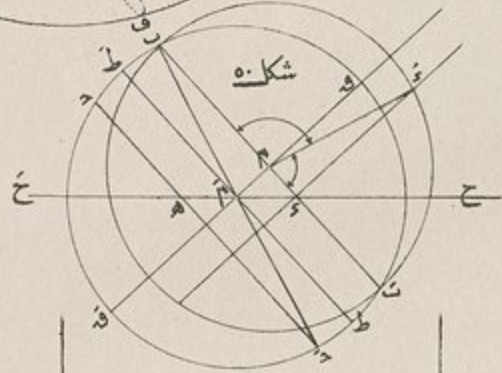

شكلا ٥١

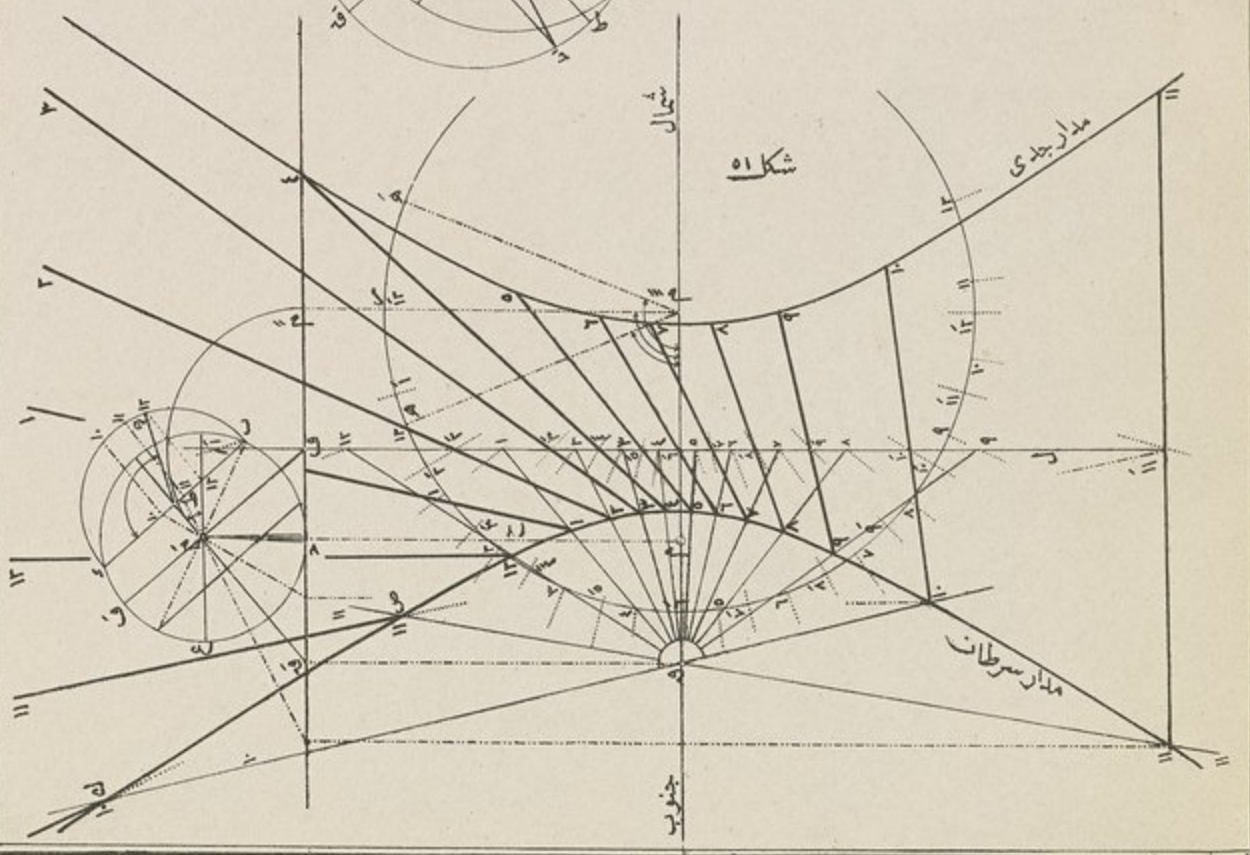

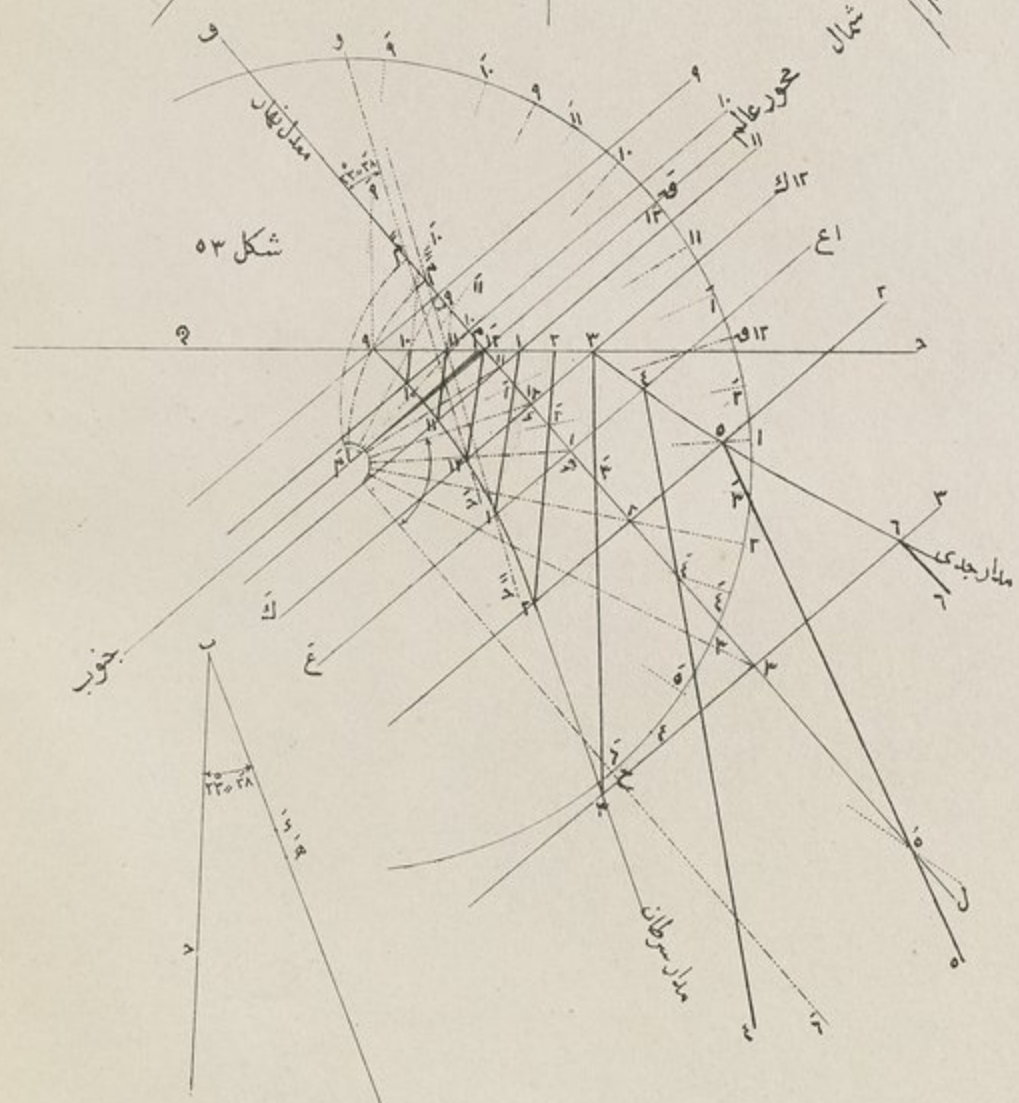
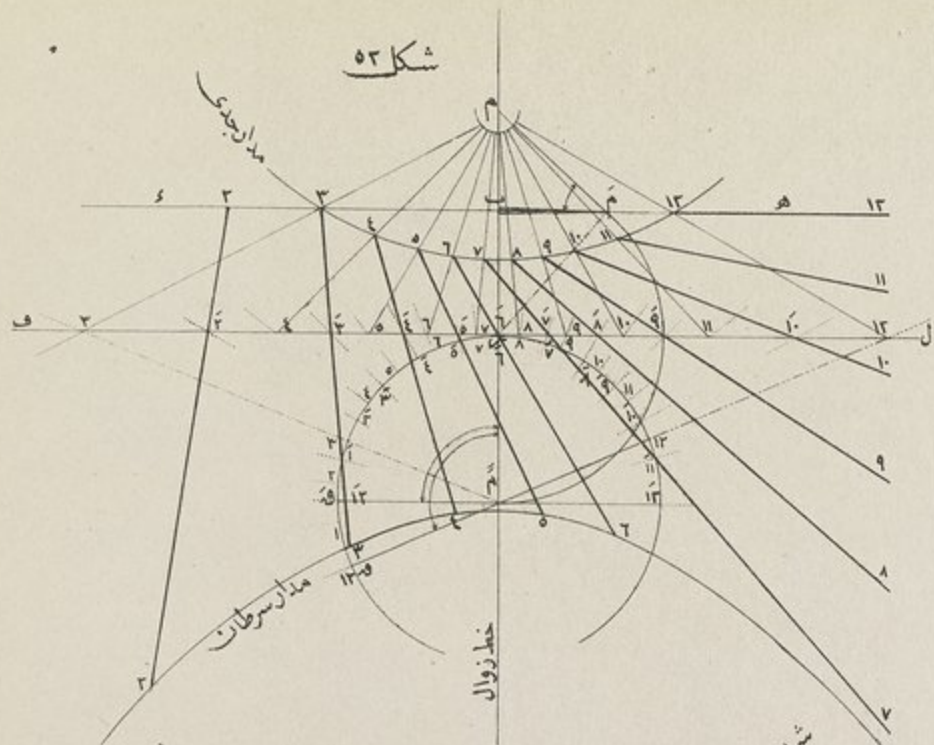

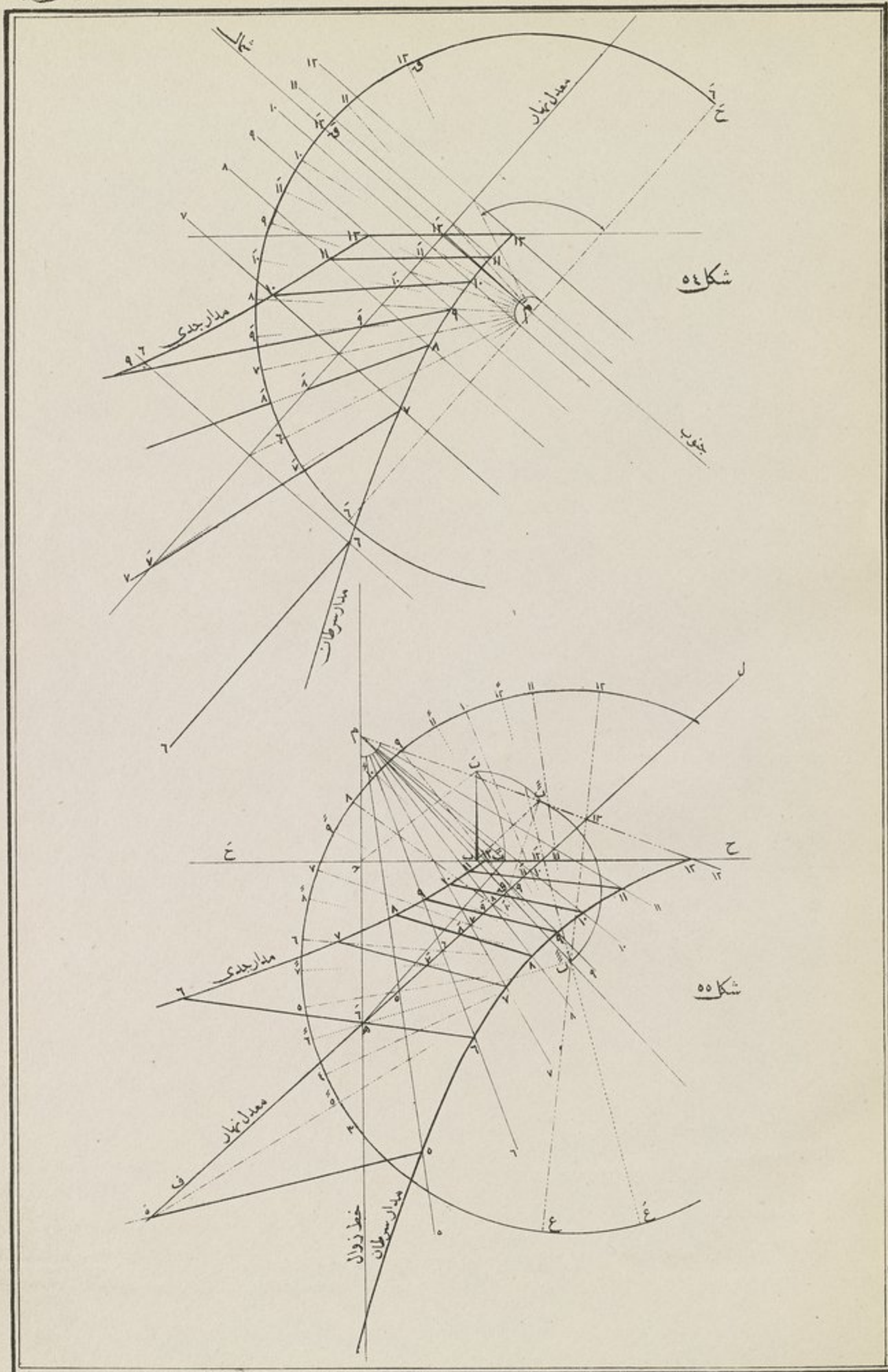

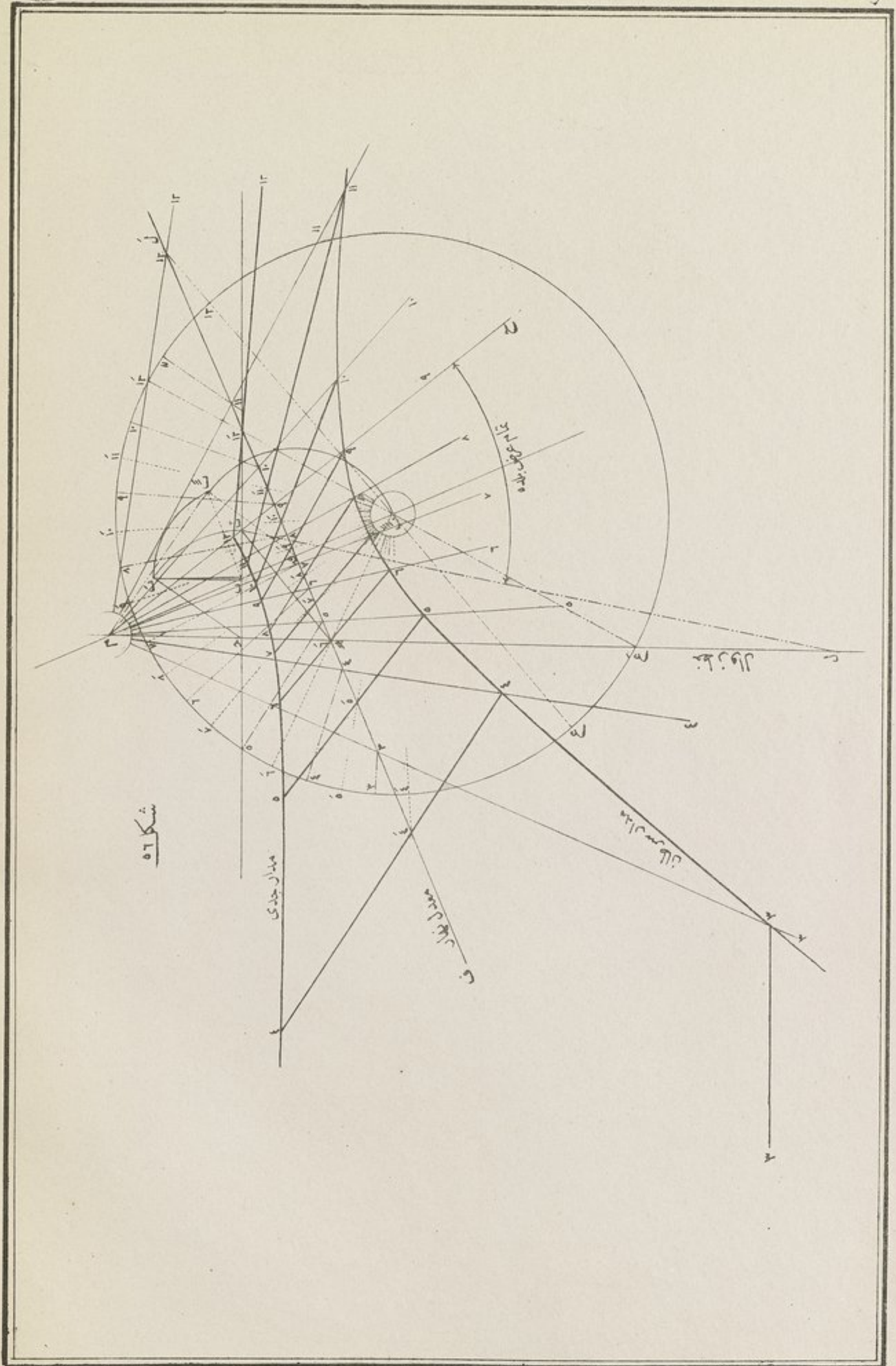

شكلا ٥

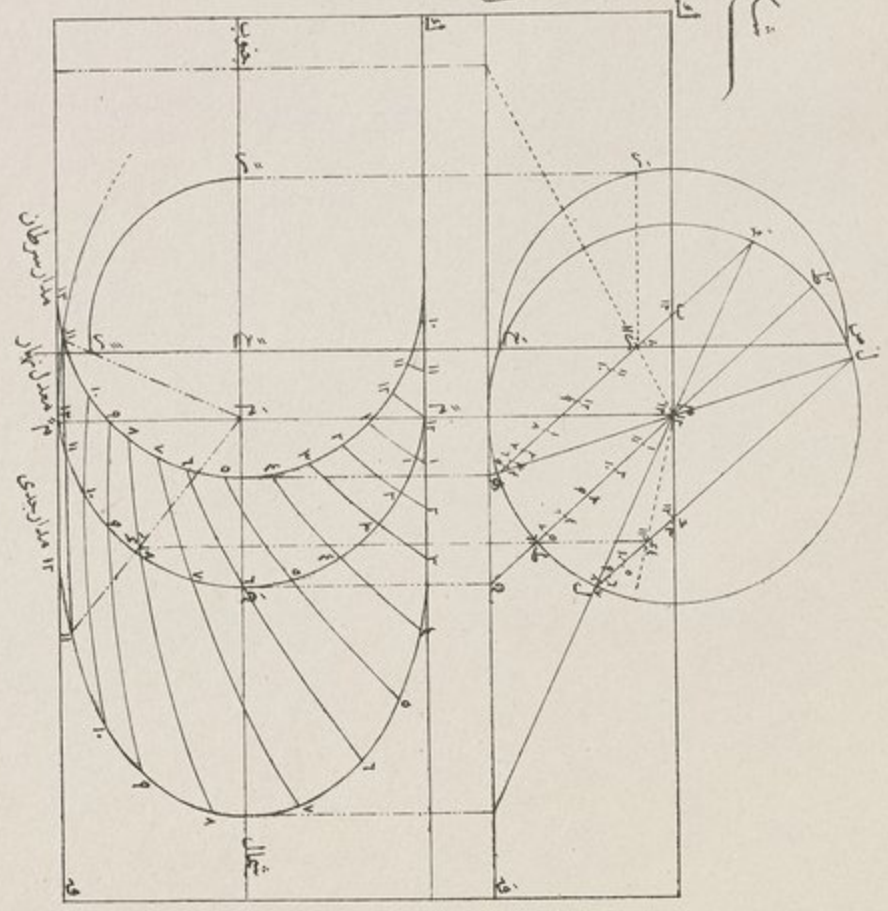
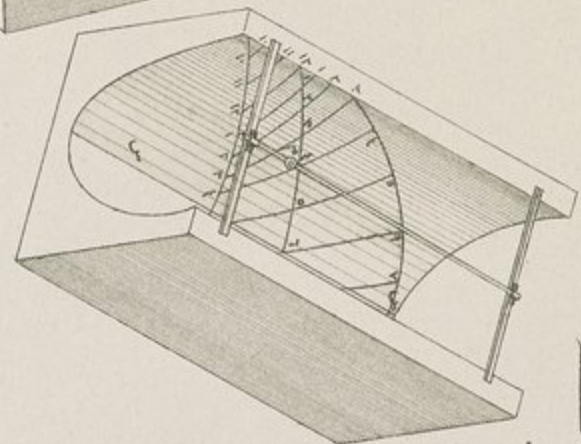
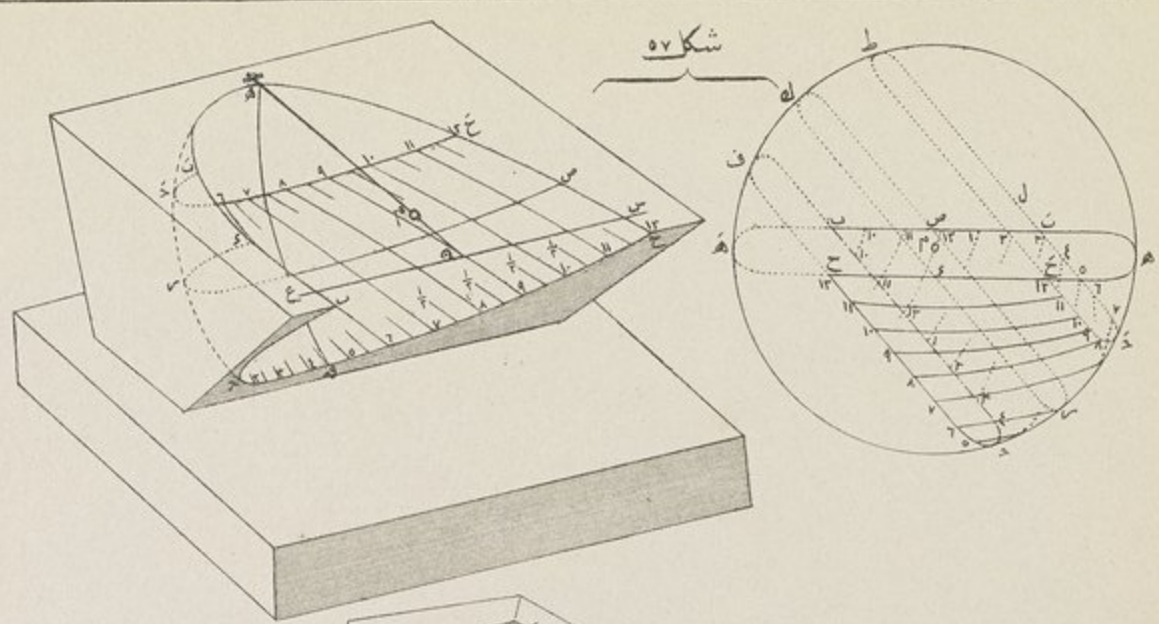

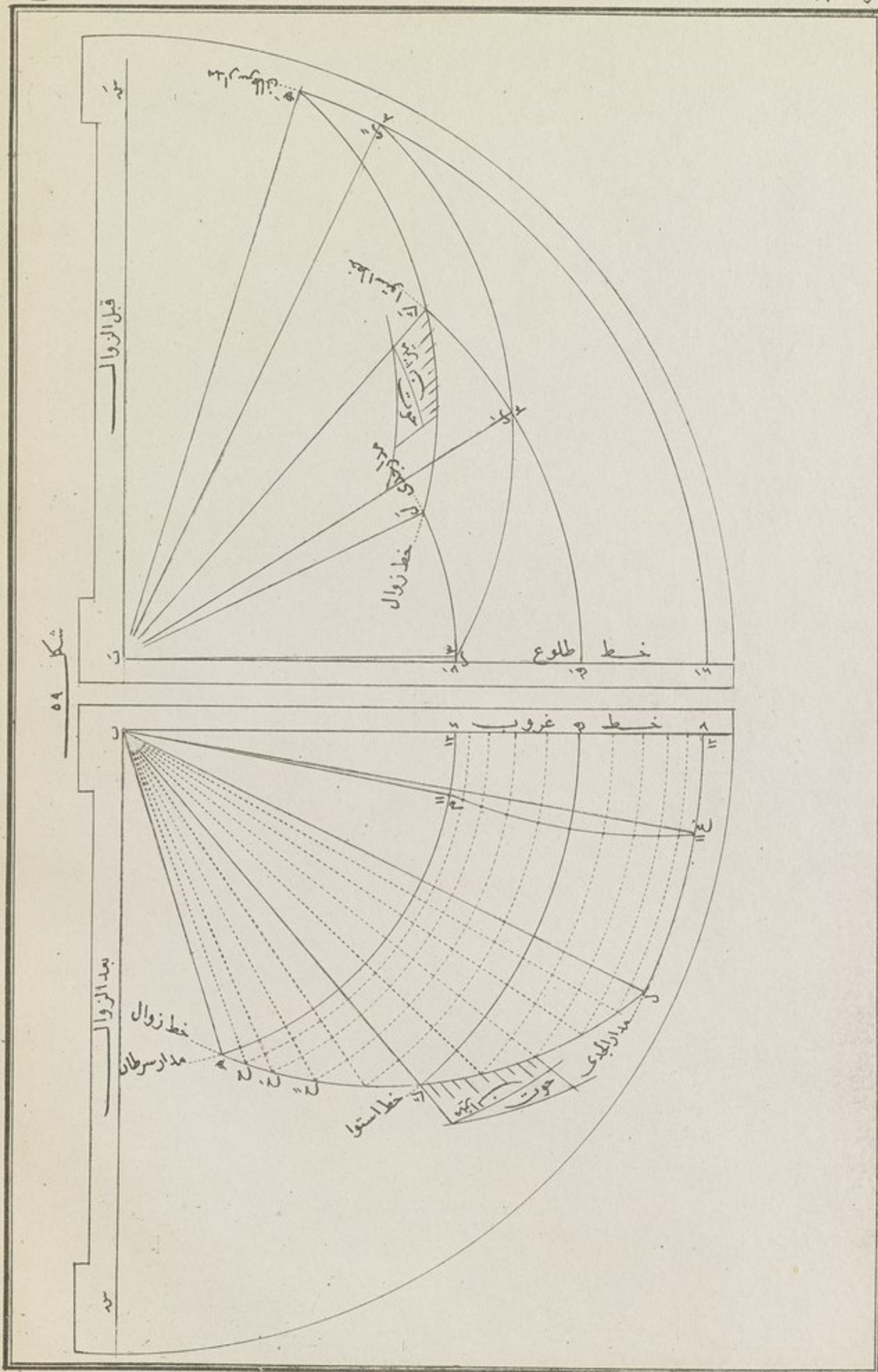

شكل ٦١

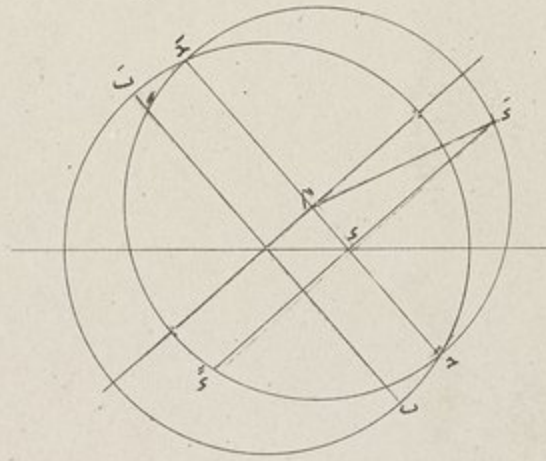

شكل ٦٠

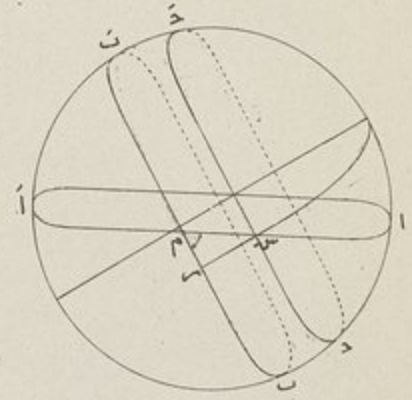

شكل ٦٢ قبل الزوال

هدفة بالا

هدفة زير

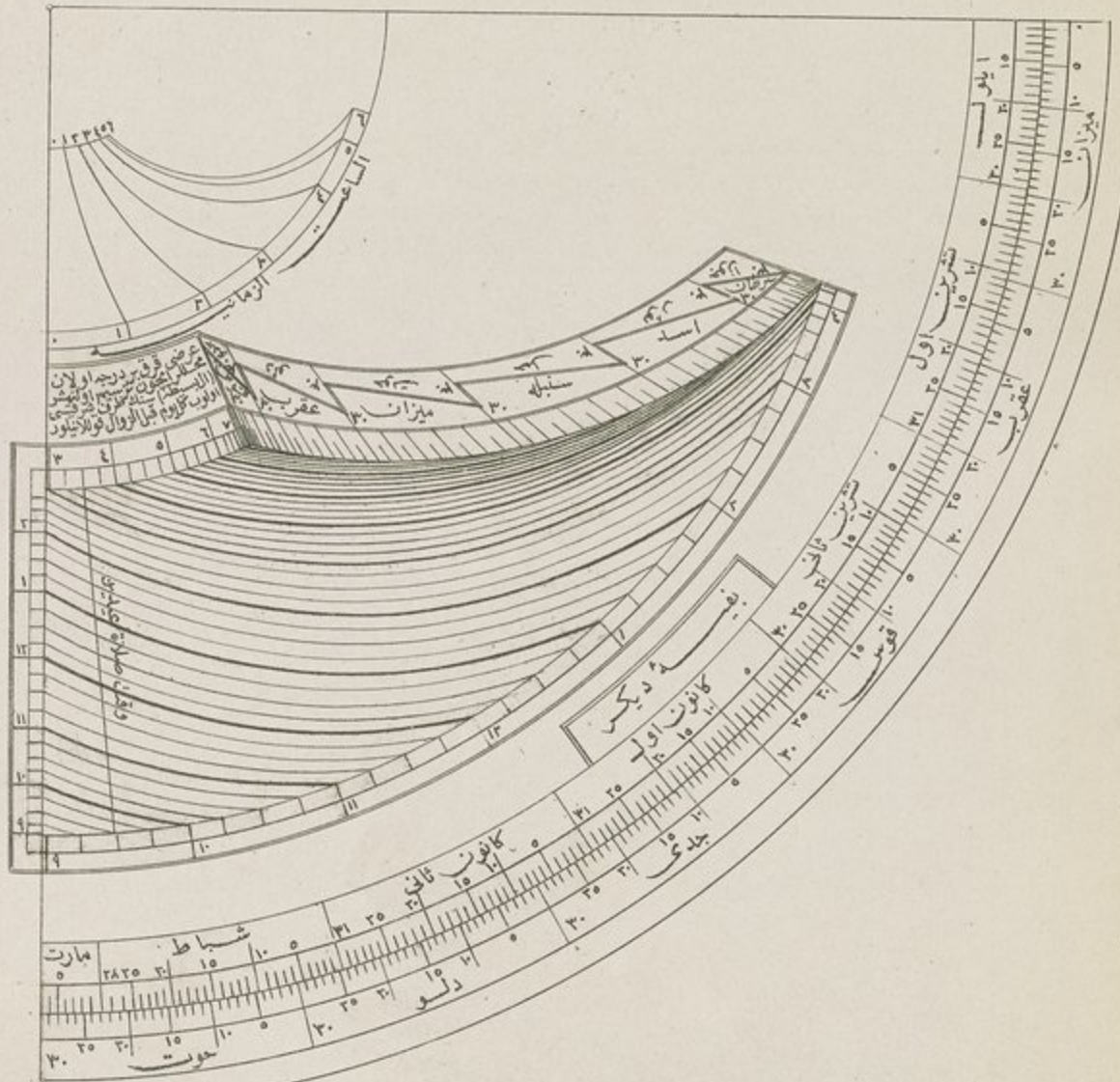

شکل ۶۳

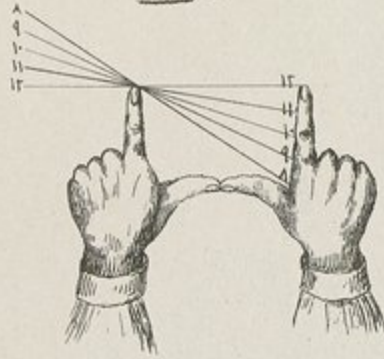

شکل ۶۲ بعد الزوال

مدفء بالا

مدفء زیر

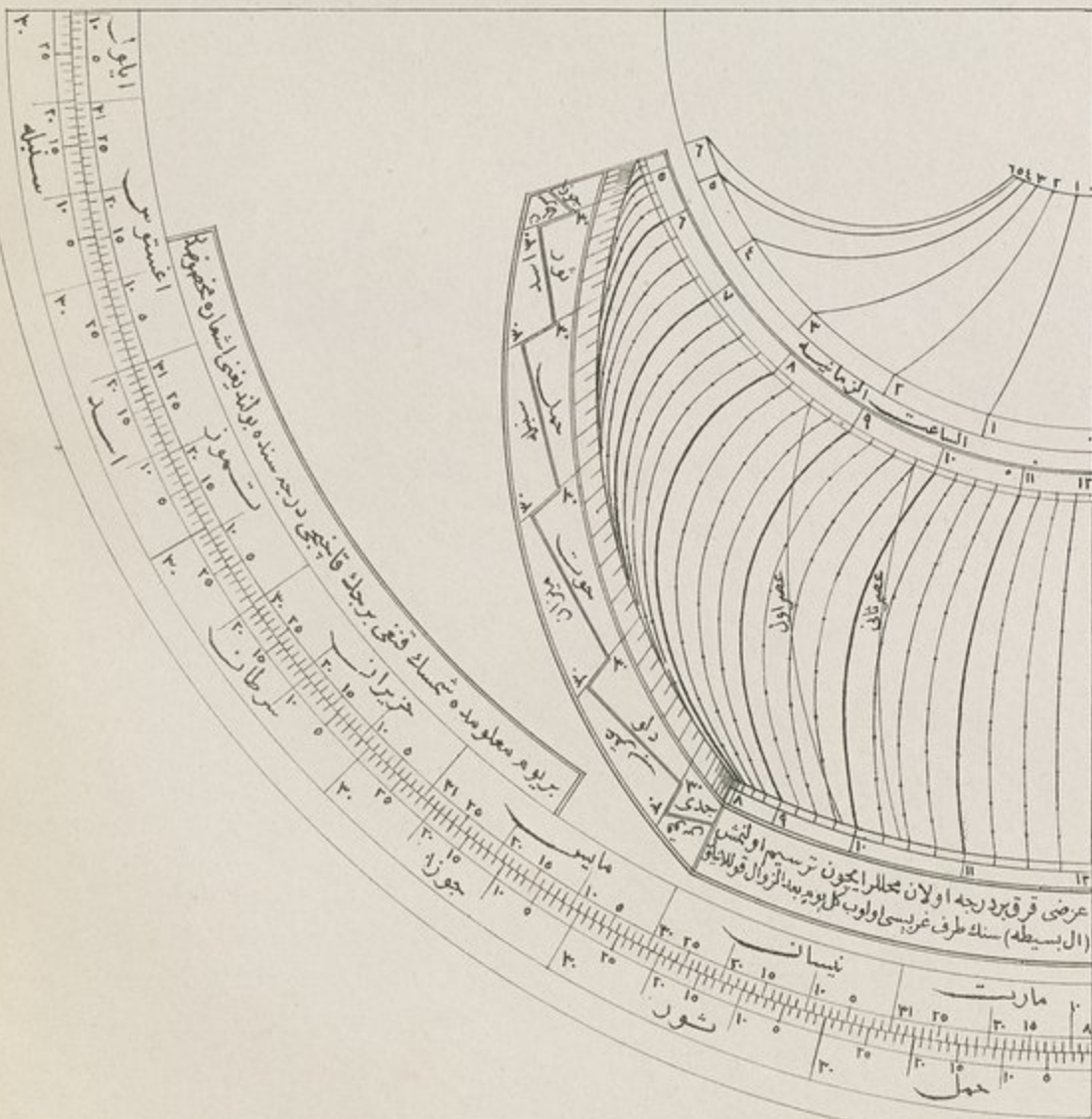

شکل ۶۴

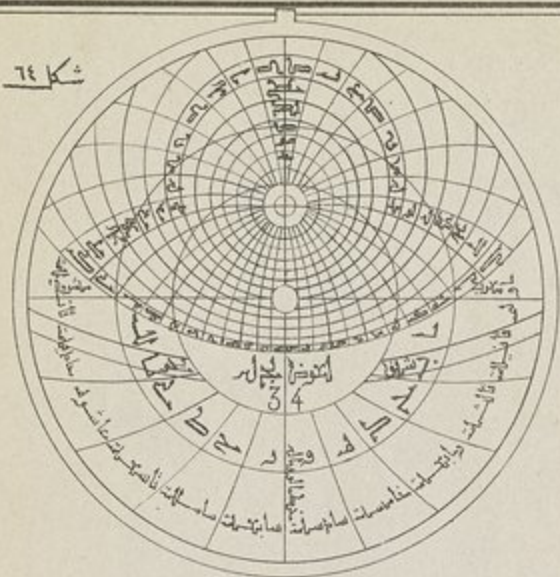

وجه الاسطرلاب قطعه ۲

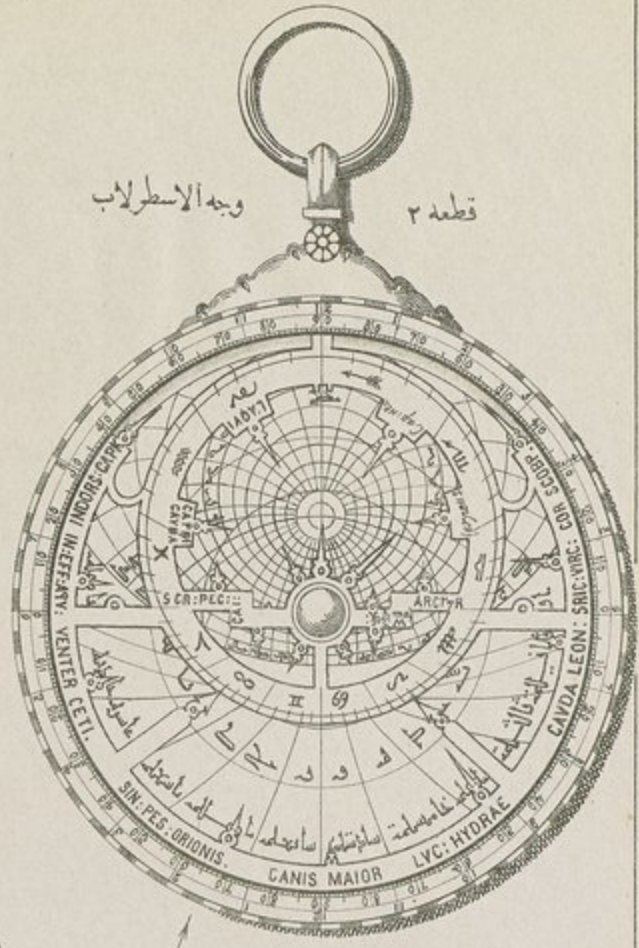

قطعه ۱
قعرام الاسطرلاب

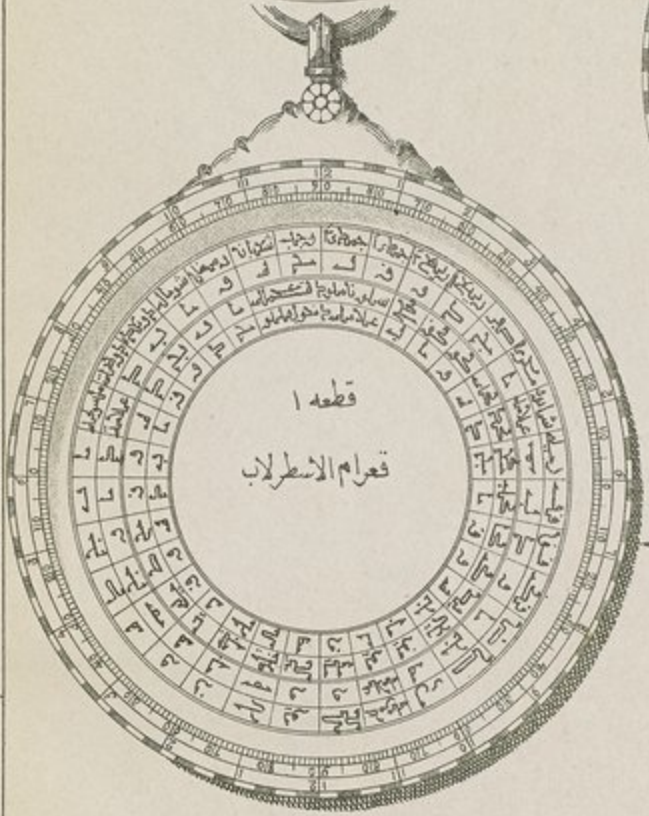

شکل ۶۵

قطعه ۳
ظهر الاسطرلاب

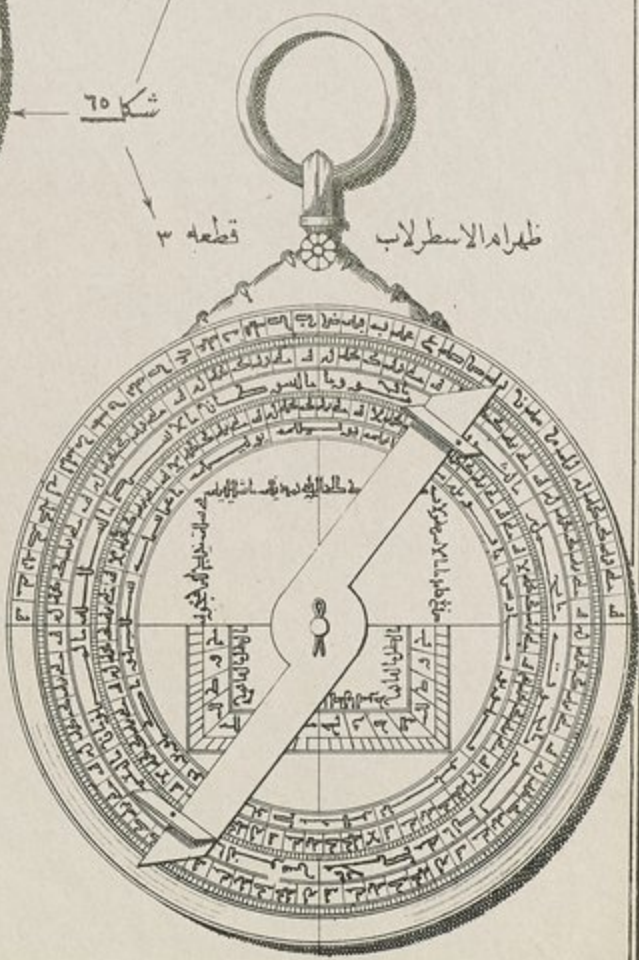

شکل ۶۶

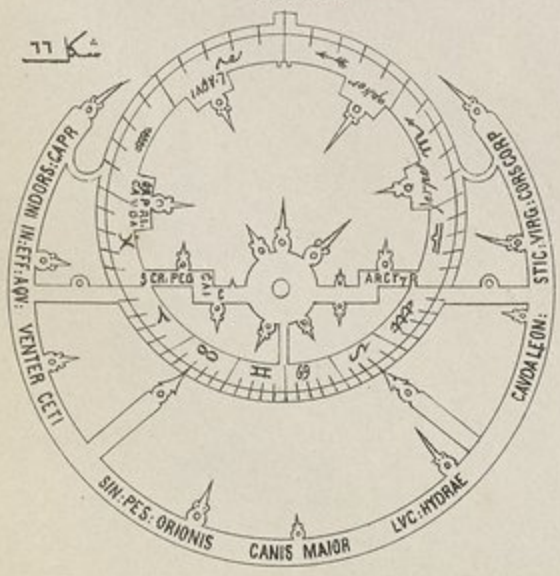

مصدره بولدغيم اسطرلابك وجريددر



صاحب المختار محمد
موقت بايزيد

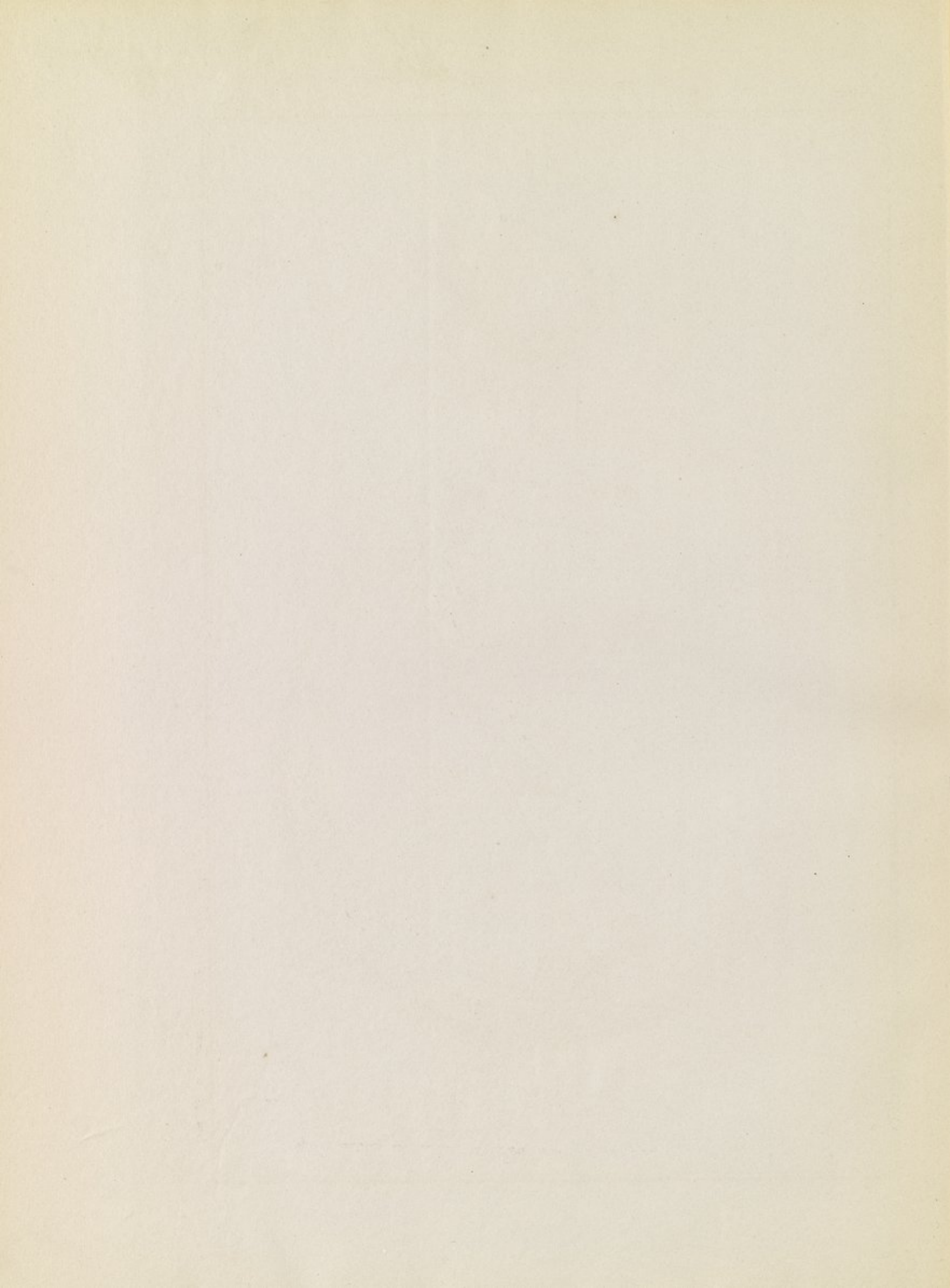

اسطرلاب مذکورک ظهر بدير

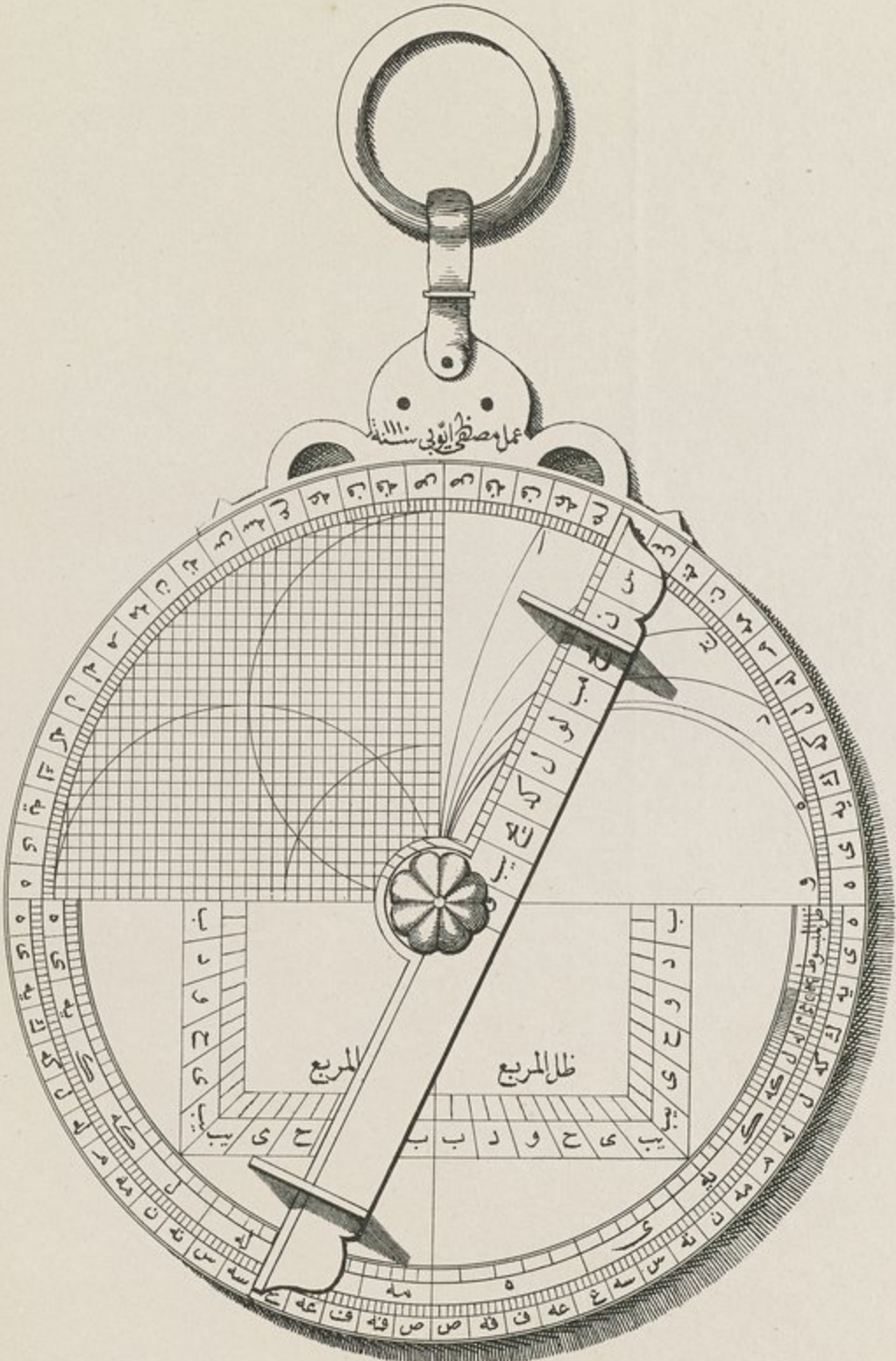

شكر ٦٧

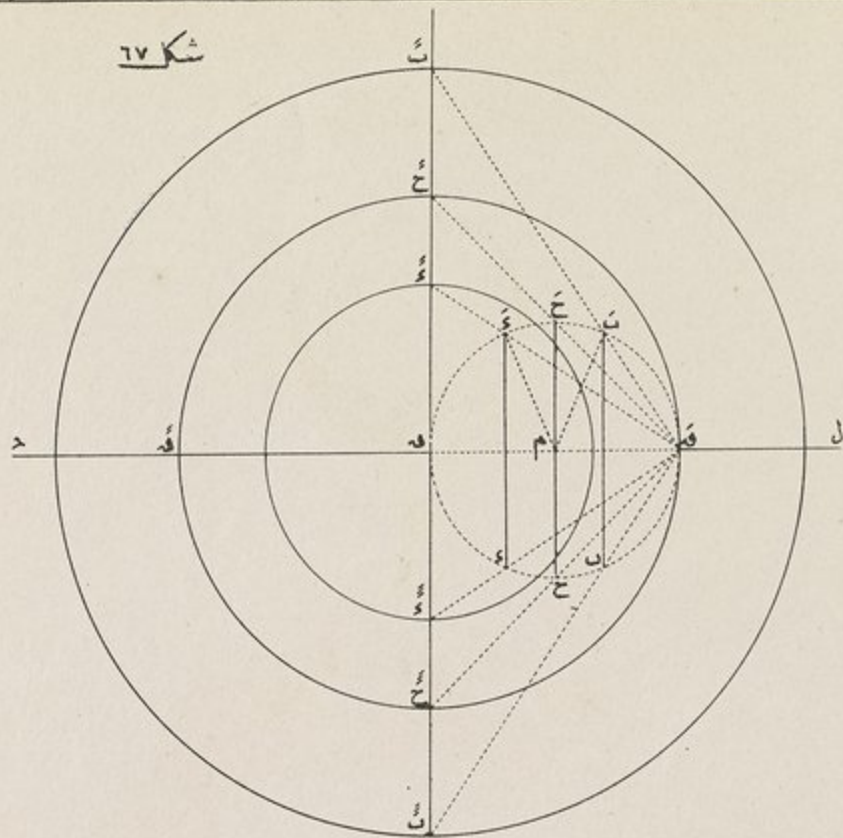

شكر ٦٨

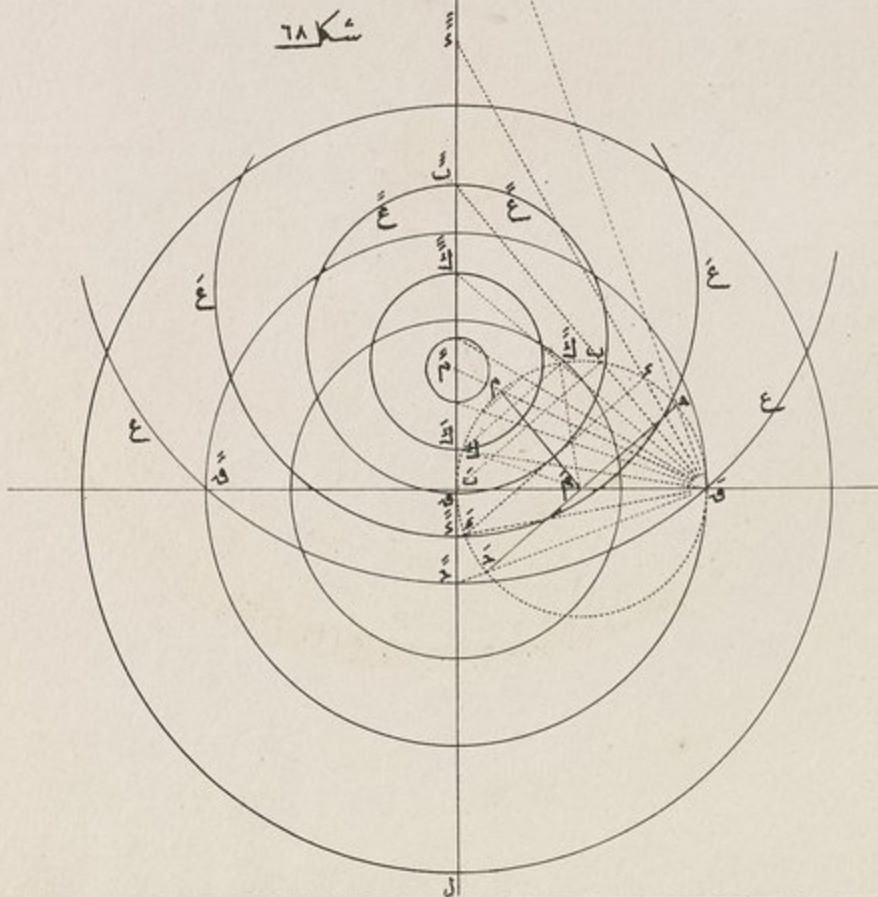

شكل ٦٩

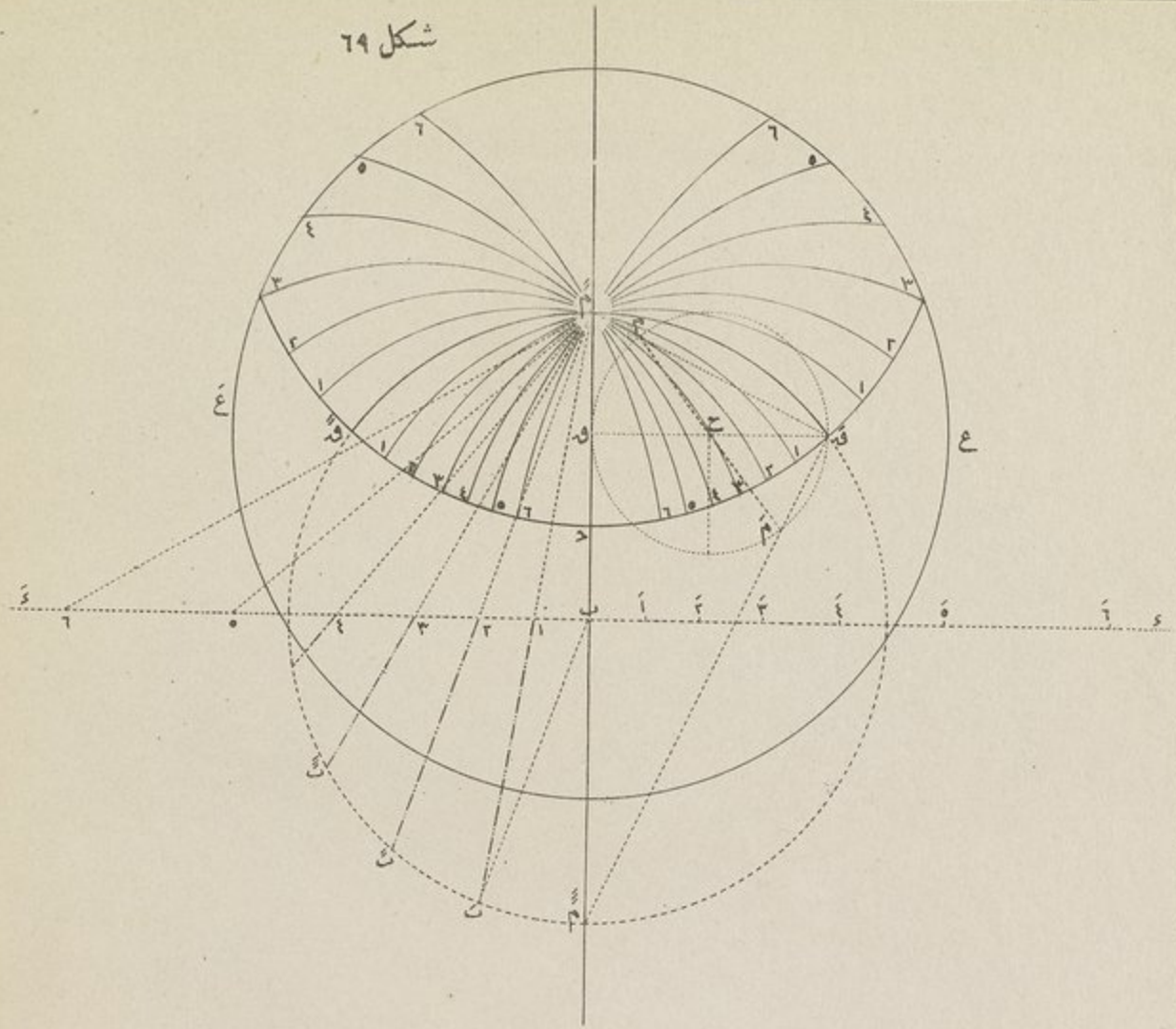

شكل ٧٠

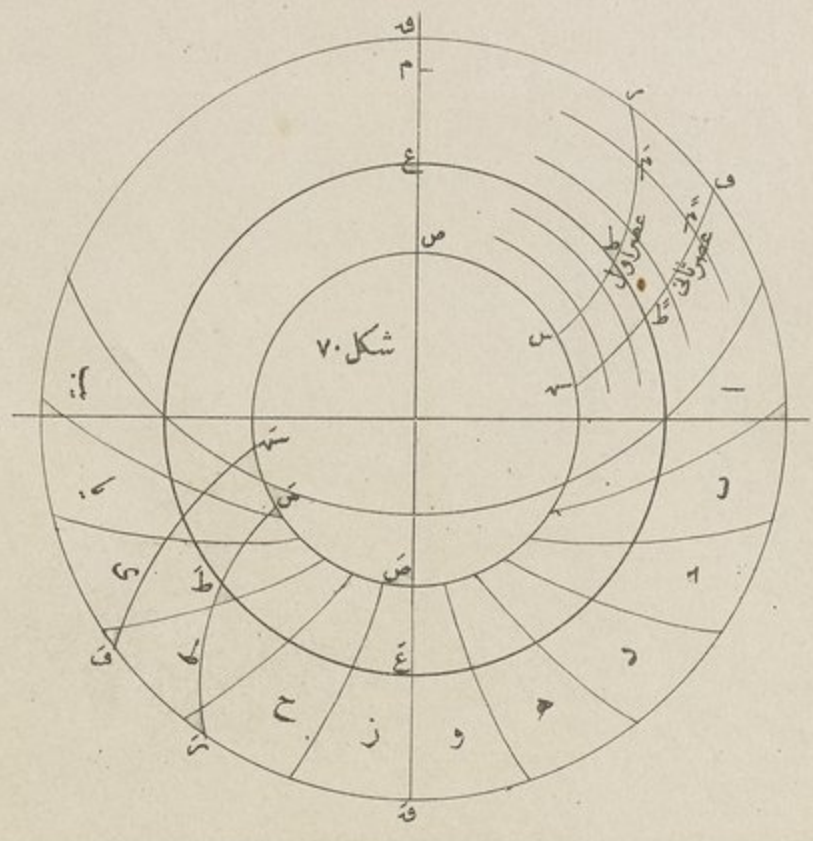

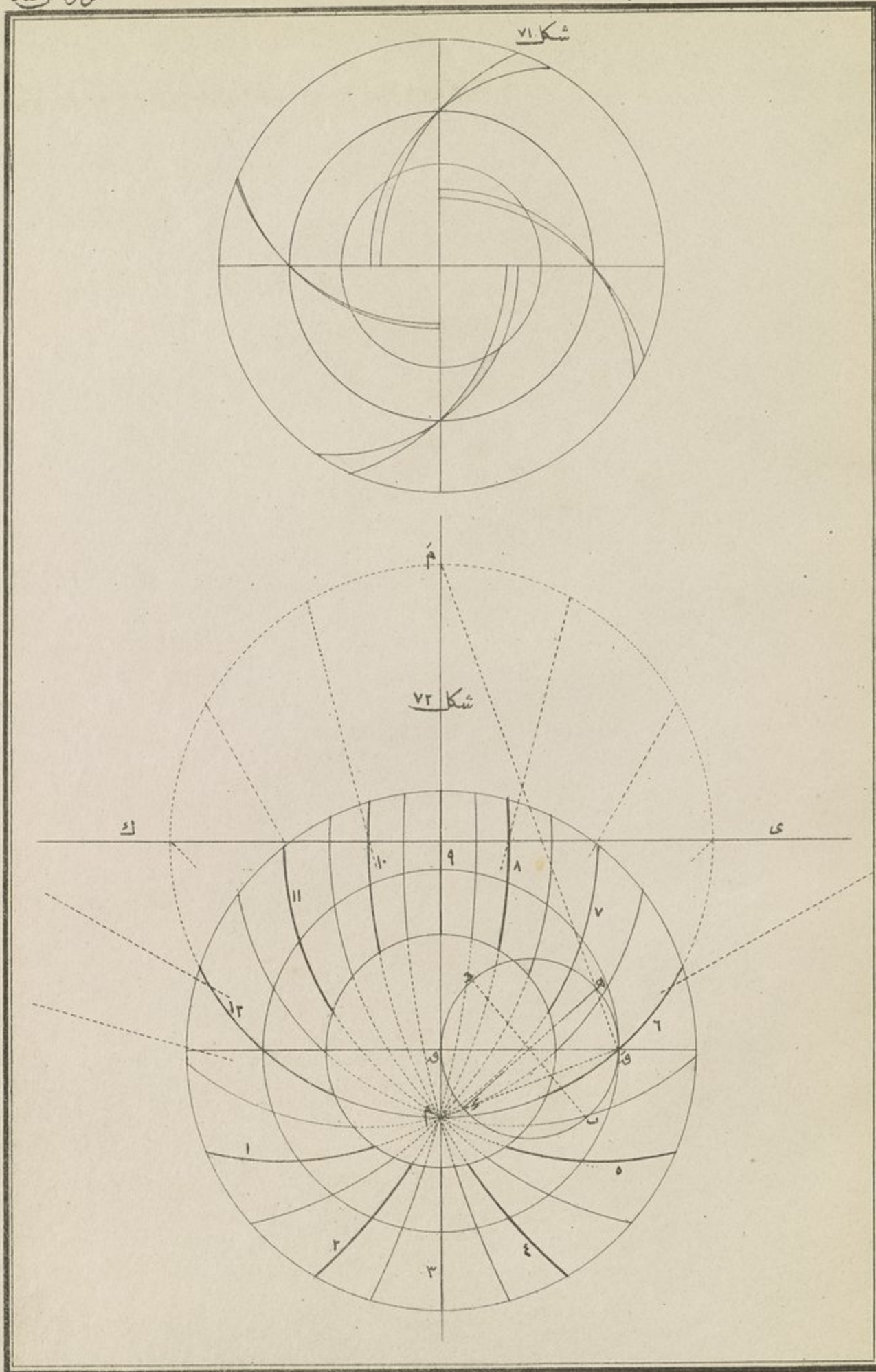

شكل ٧٣

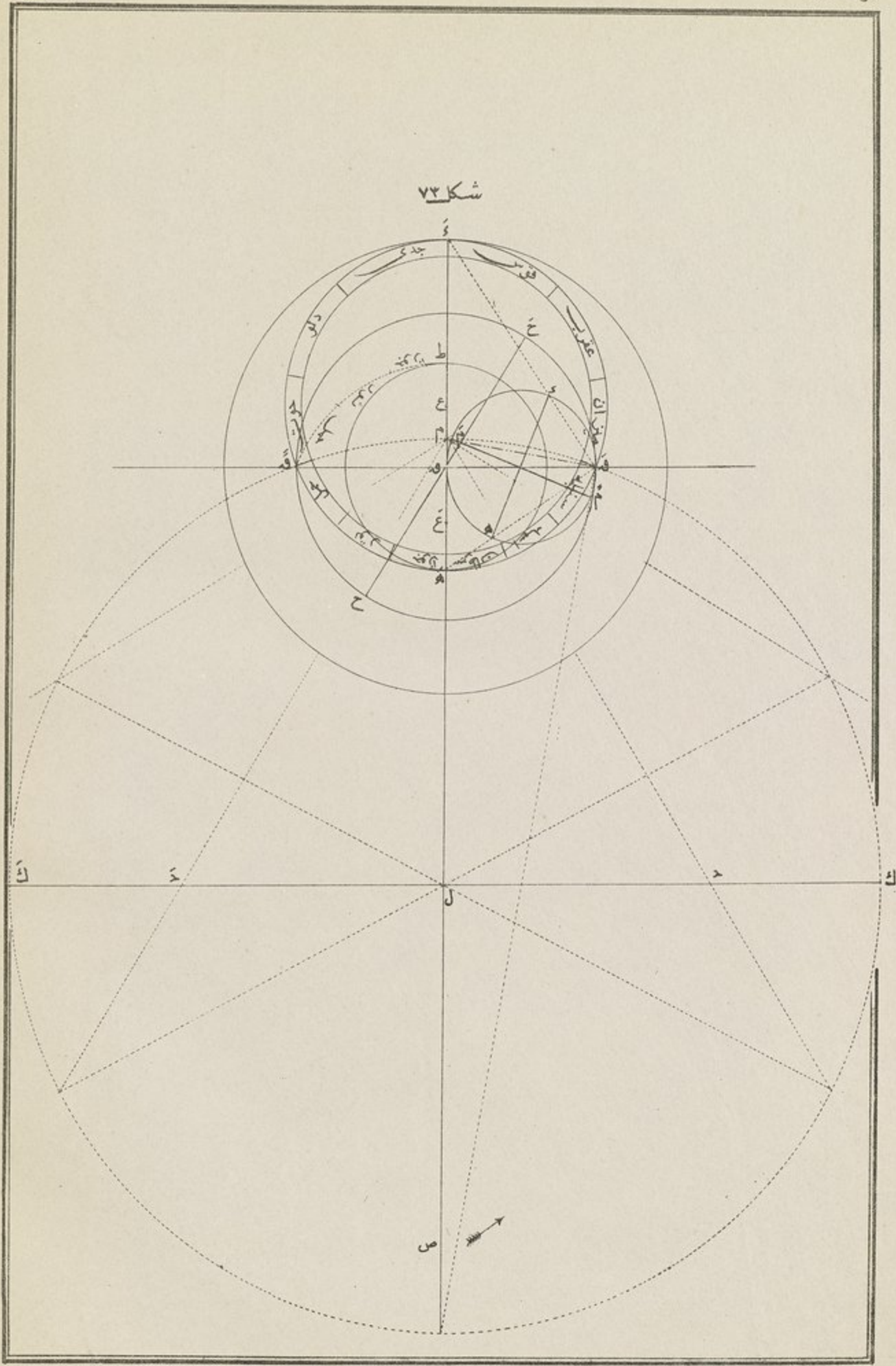

شكلا ٧٤

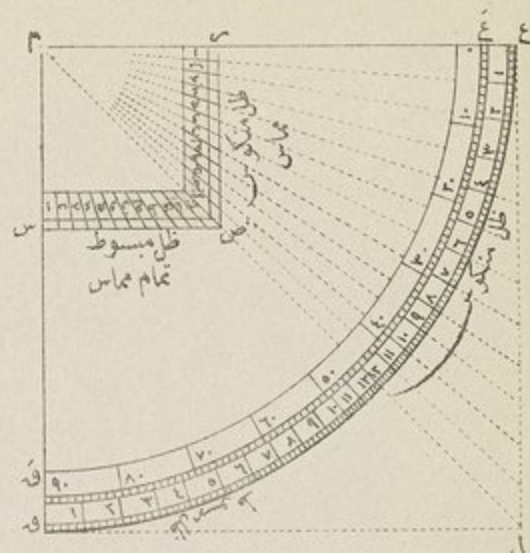

شكلا ٧٥

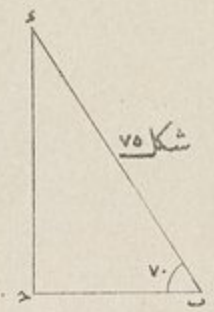

شكلا ٧٦

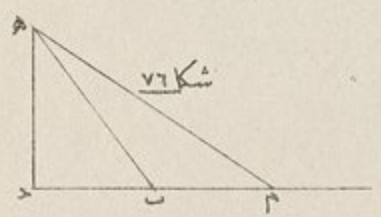

شكلا ٧٧

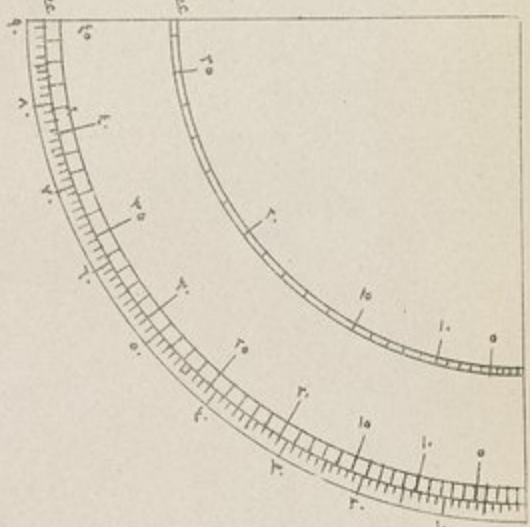

شكلا ٧٨

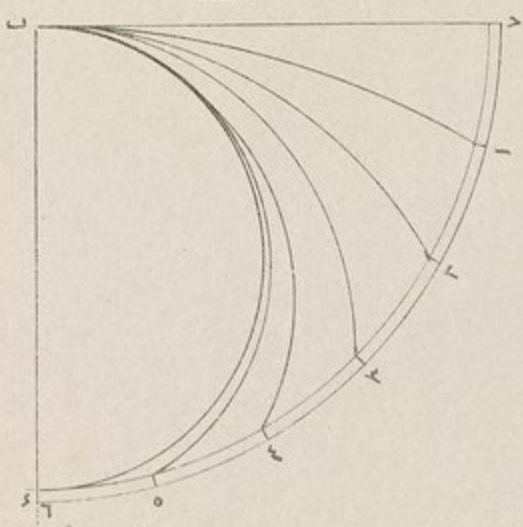

شكلا ٨٠

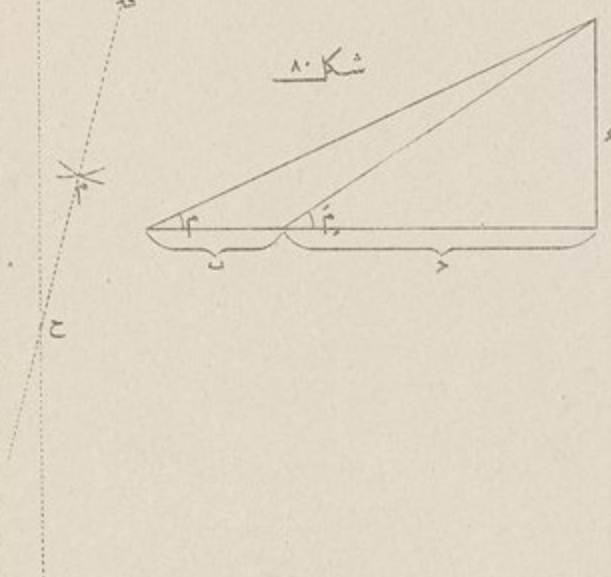

شكلا ٧٩

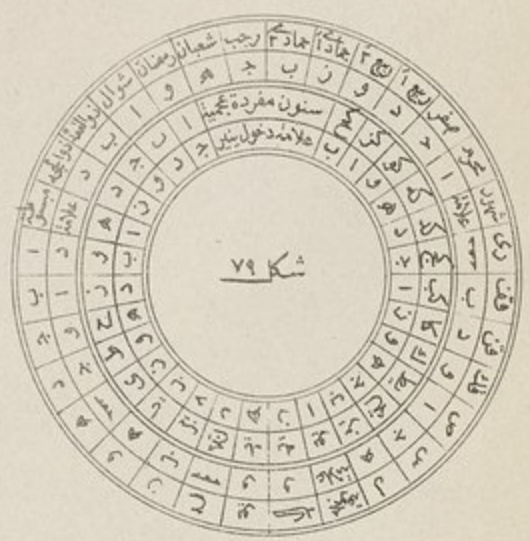

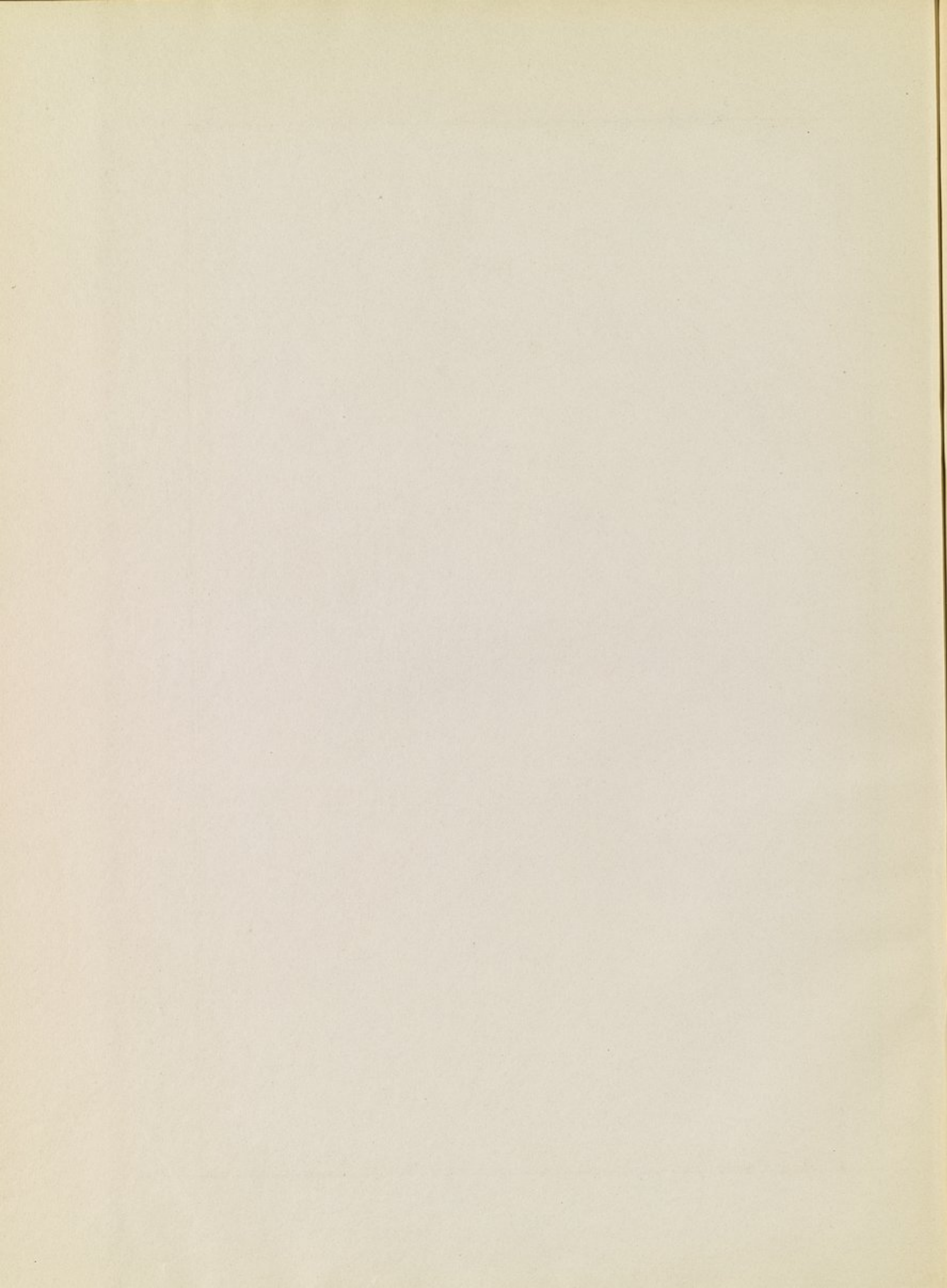

شكل ٨١

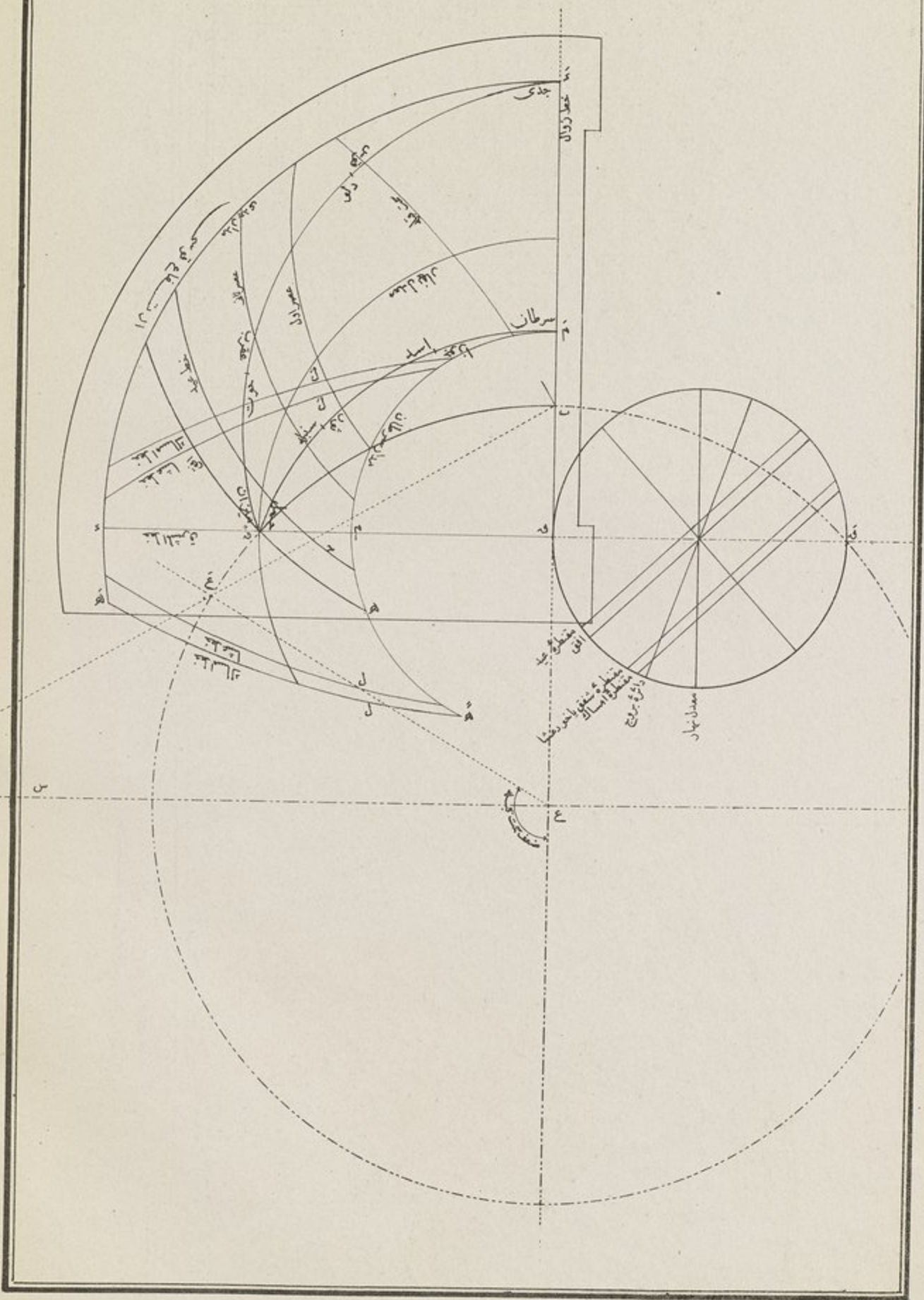

شکل ٨٢ ربع الجیب : ربع الدنور

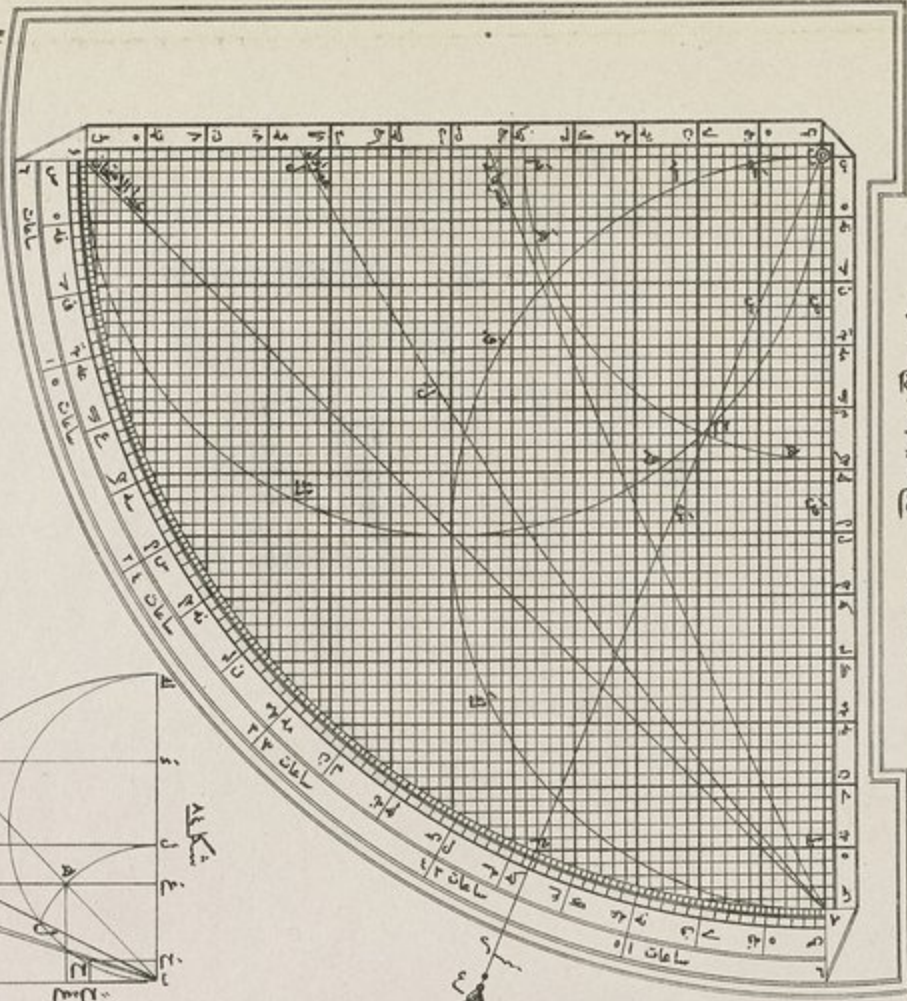

سکسان ربع شکره مکمل الرسم او الفسیدر
ربع القطره العرض ما

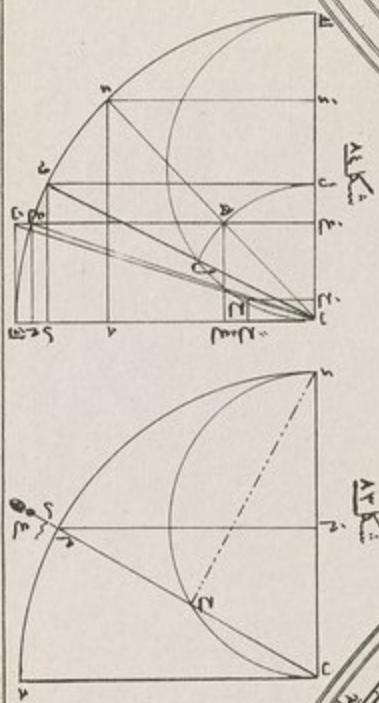
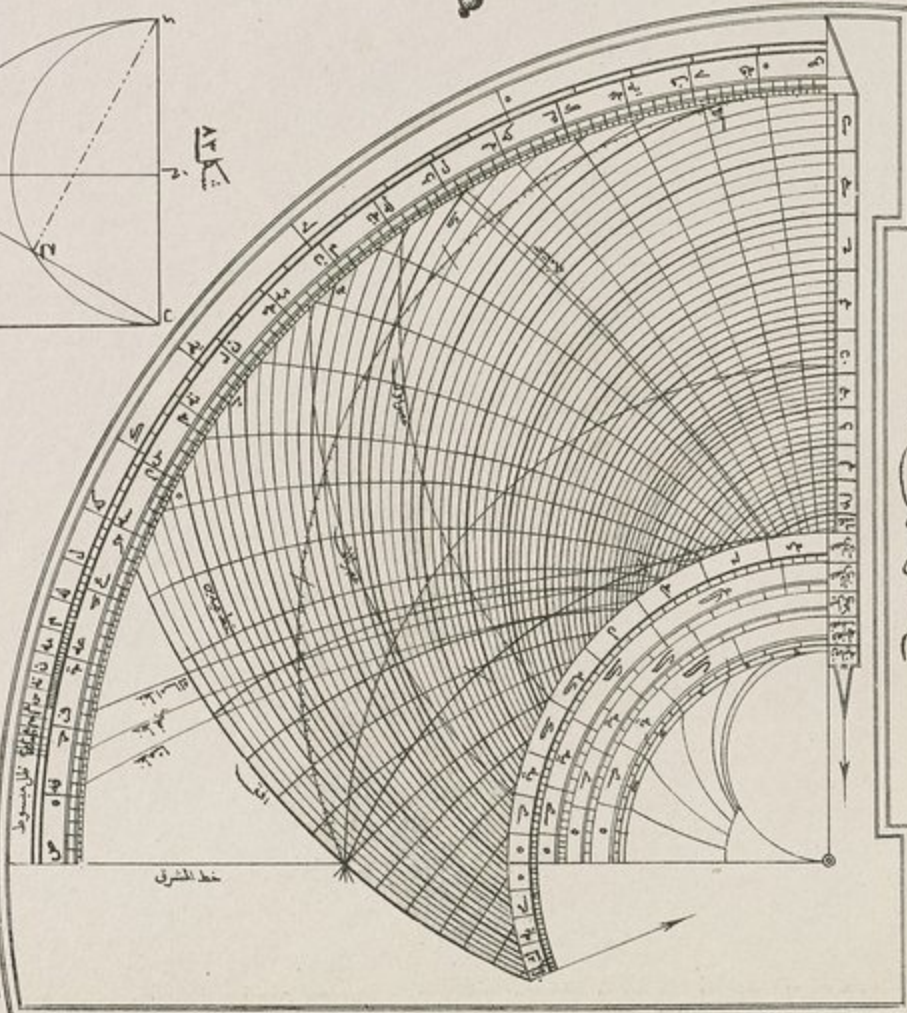

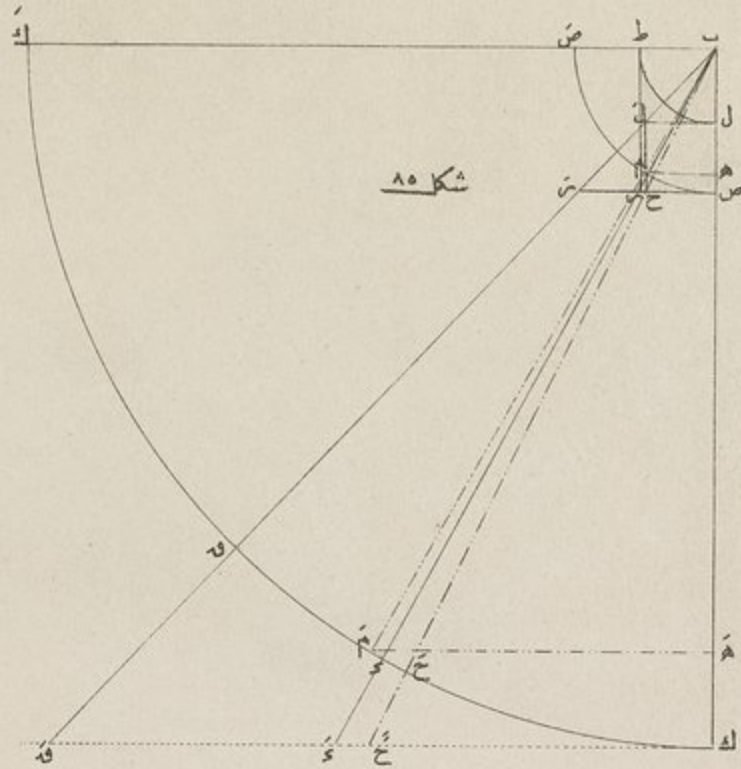

شكلا ٨٥

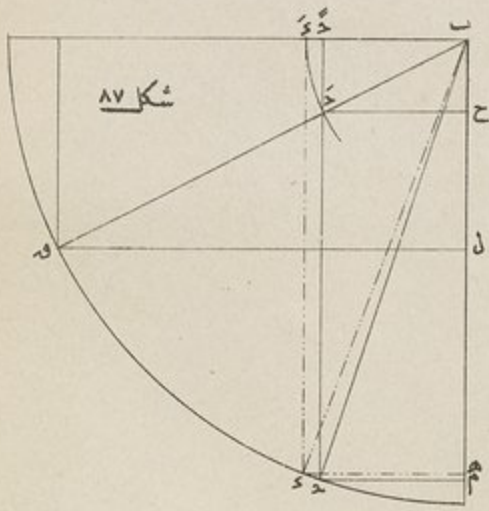

شكلا ٨٧

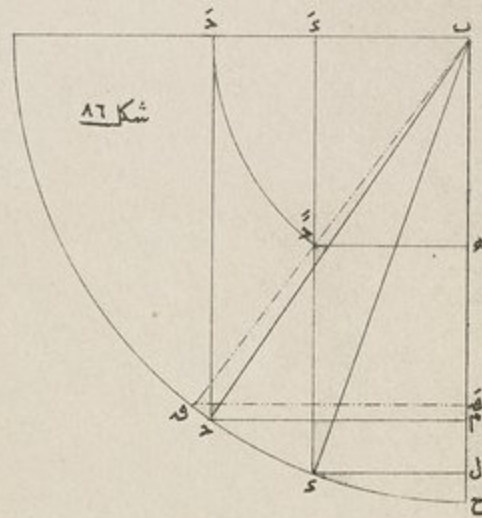

شكلا ٨٦

شكل ٨٨

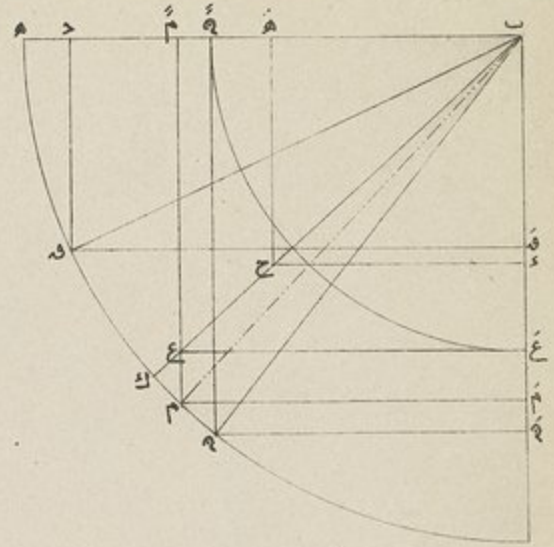

شكل ٨٩

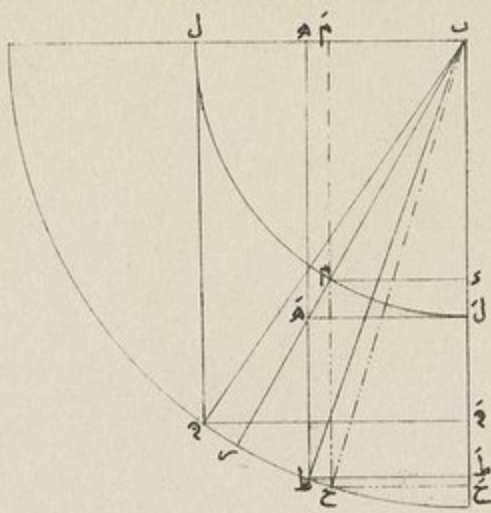

شكل ٩٠

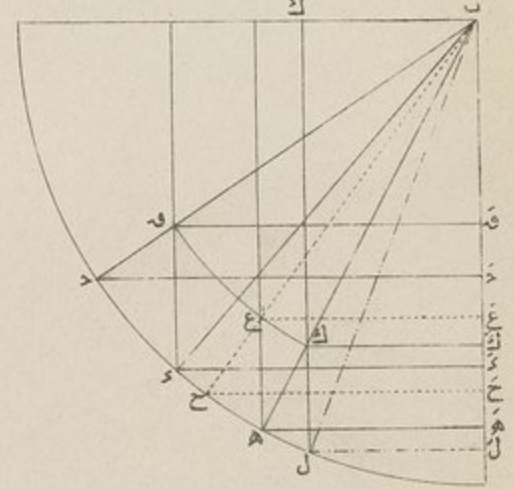

شكل ٩١

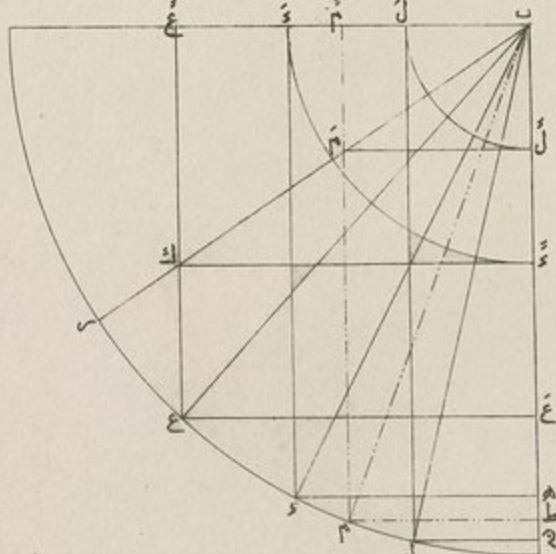

شكل ٩٢

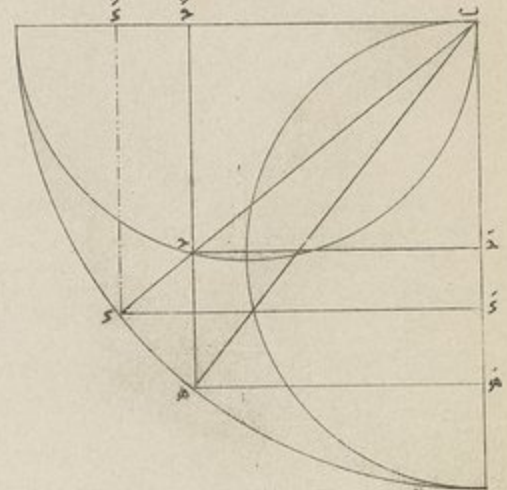

شكل ٩٣

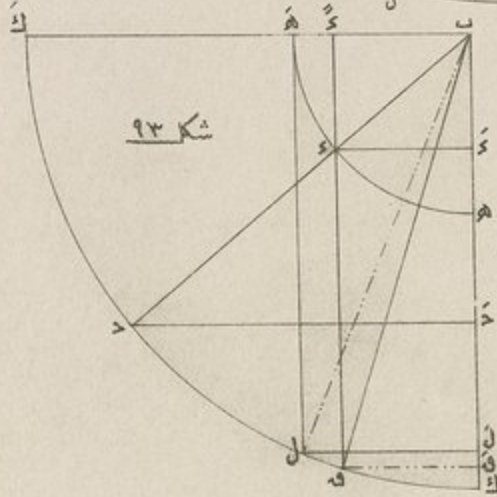

شكل ٩٥

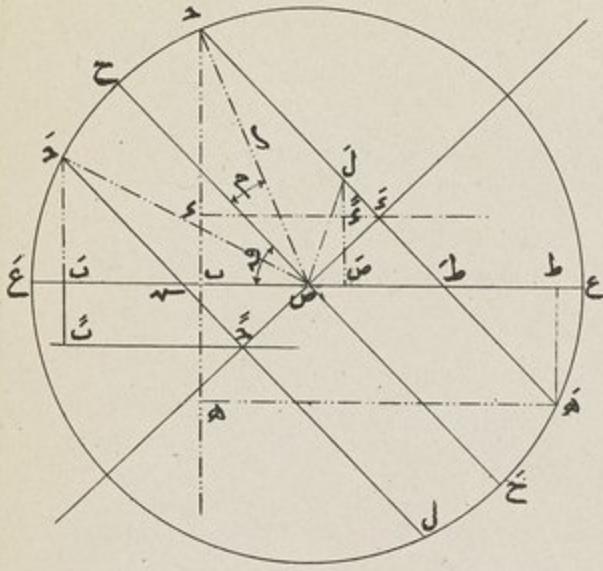

شكل ٩٤

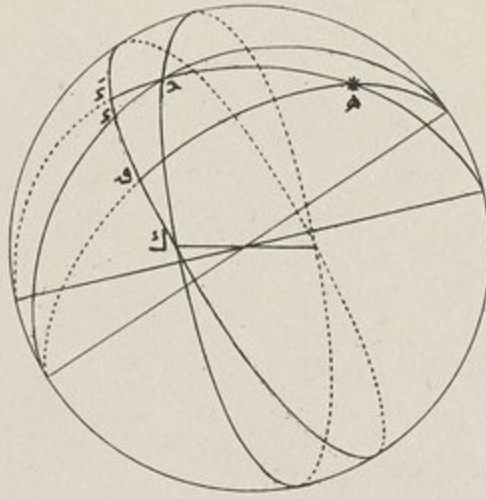

شكل ٩٧

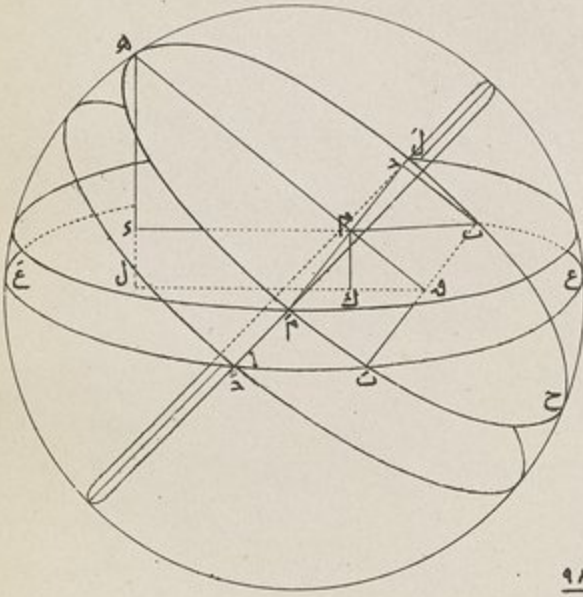

شكل ٩٦

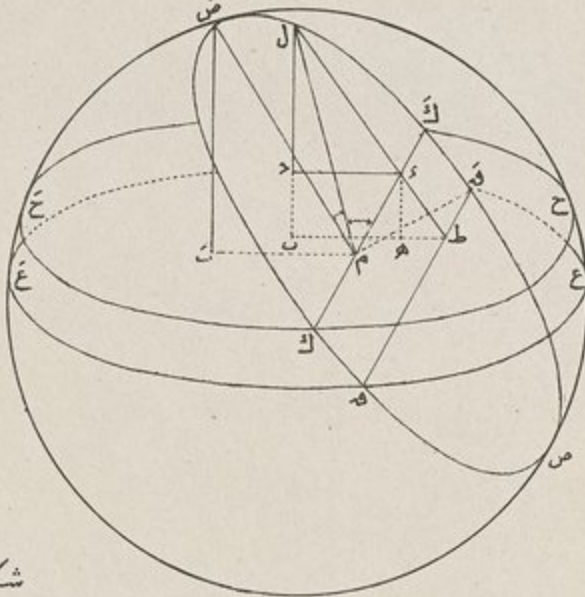

شكل ٩٨

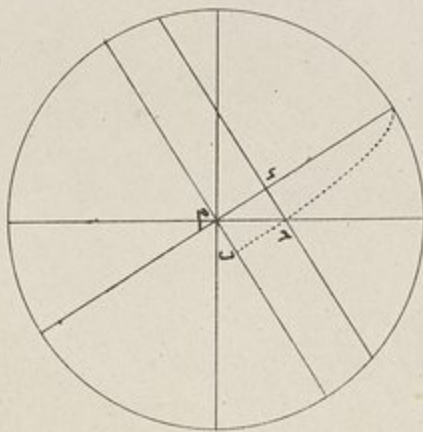

شكلا ٩٩

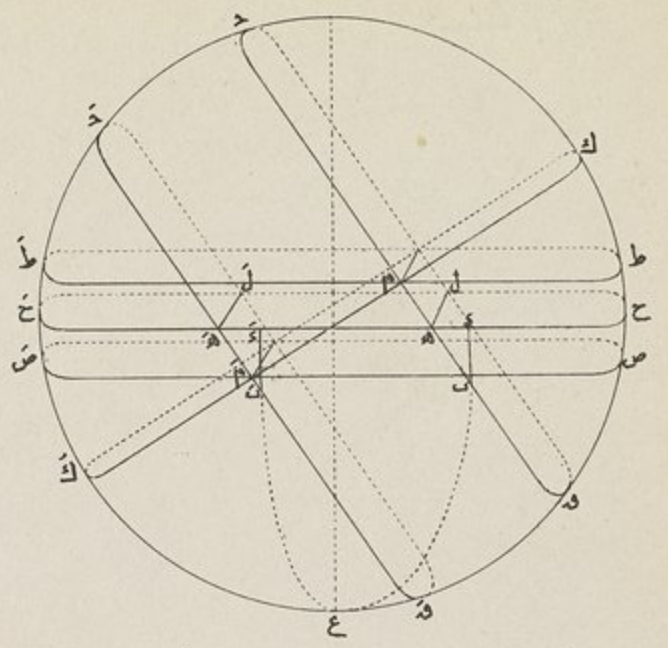

شكلا ١٠٠

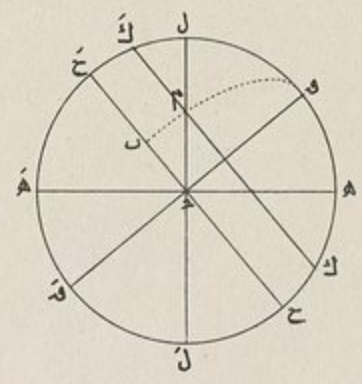

شكلا ١٠٢

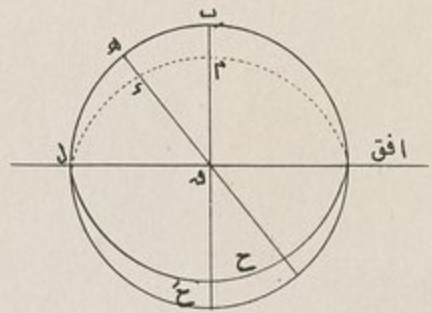

شكلا ١٠١

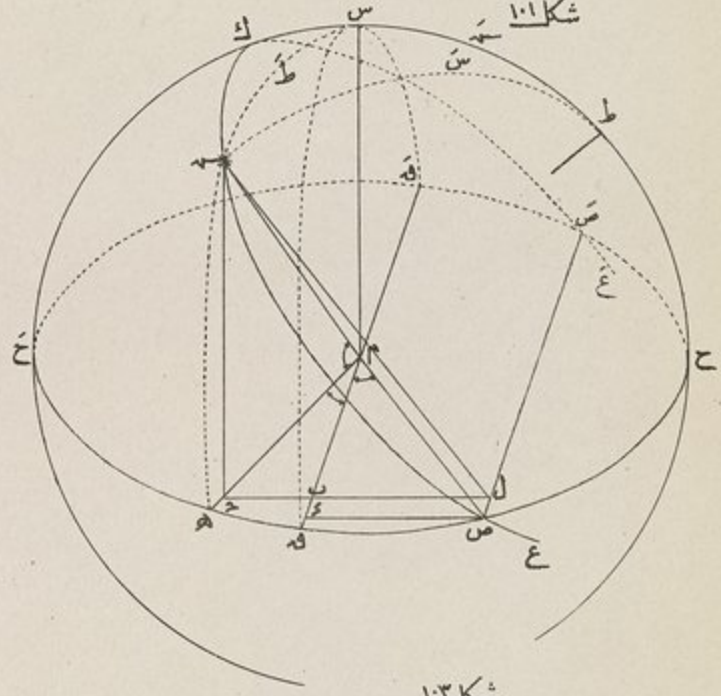

شكلا ١٠٤

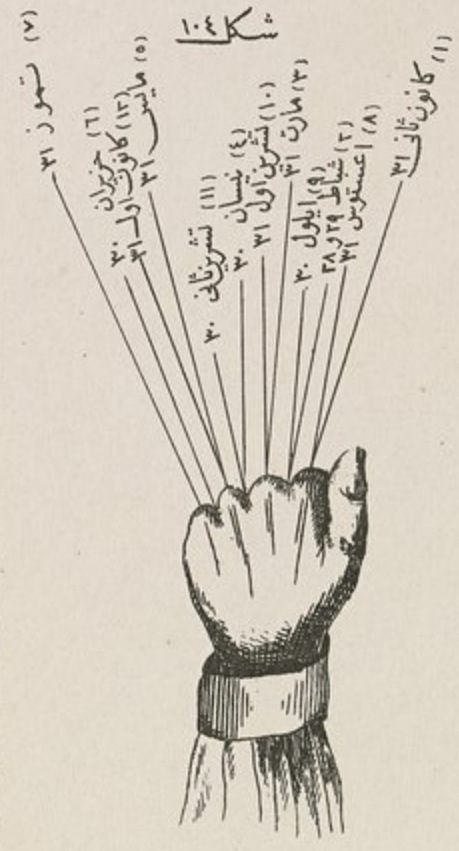

شكلا ١٠٣

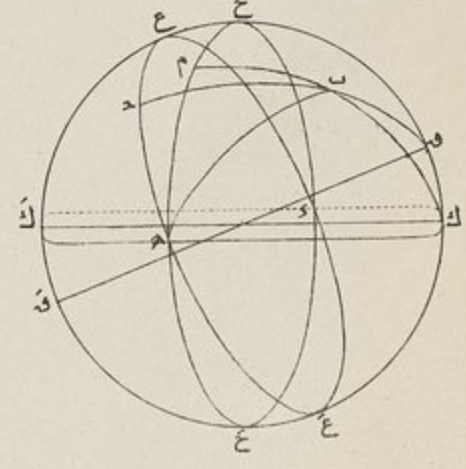

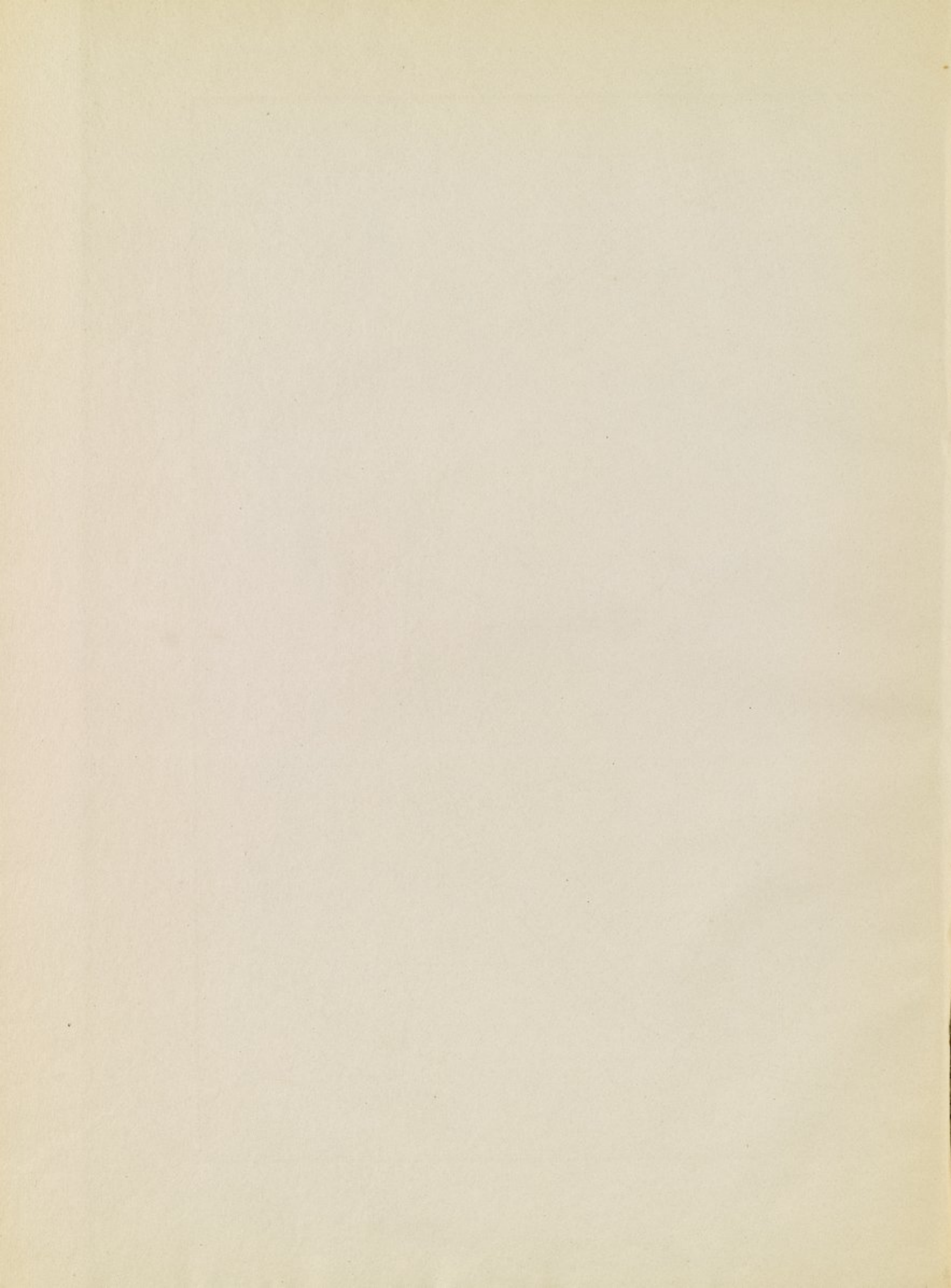

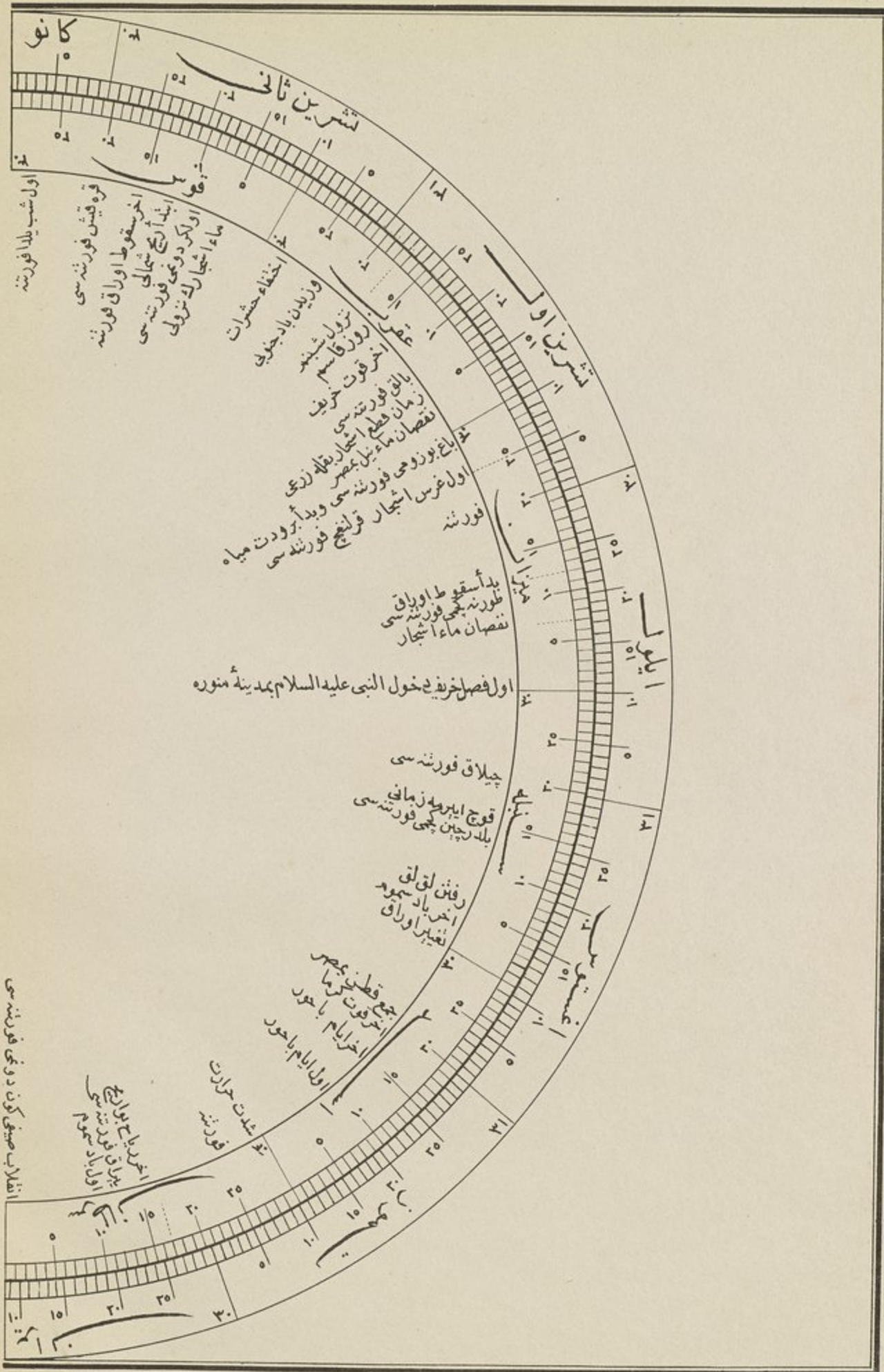

شکل

انقلاب صیفی کون دومی فورتنه سی

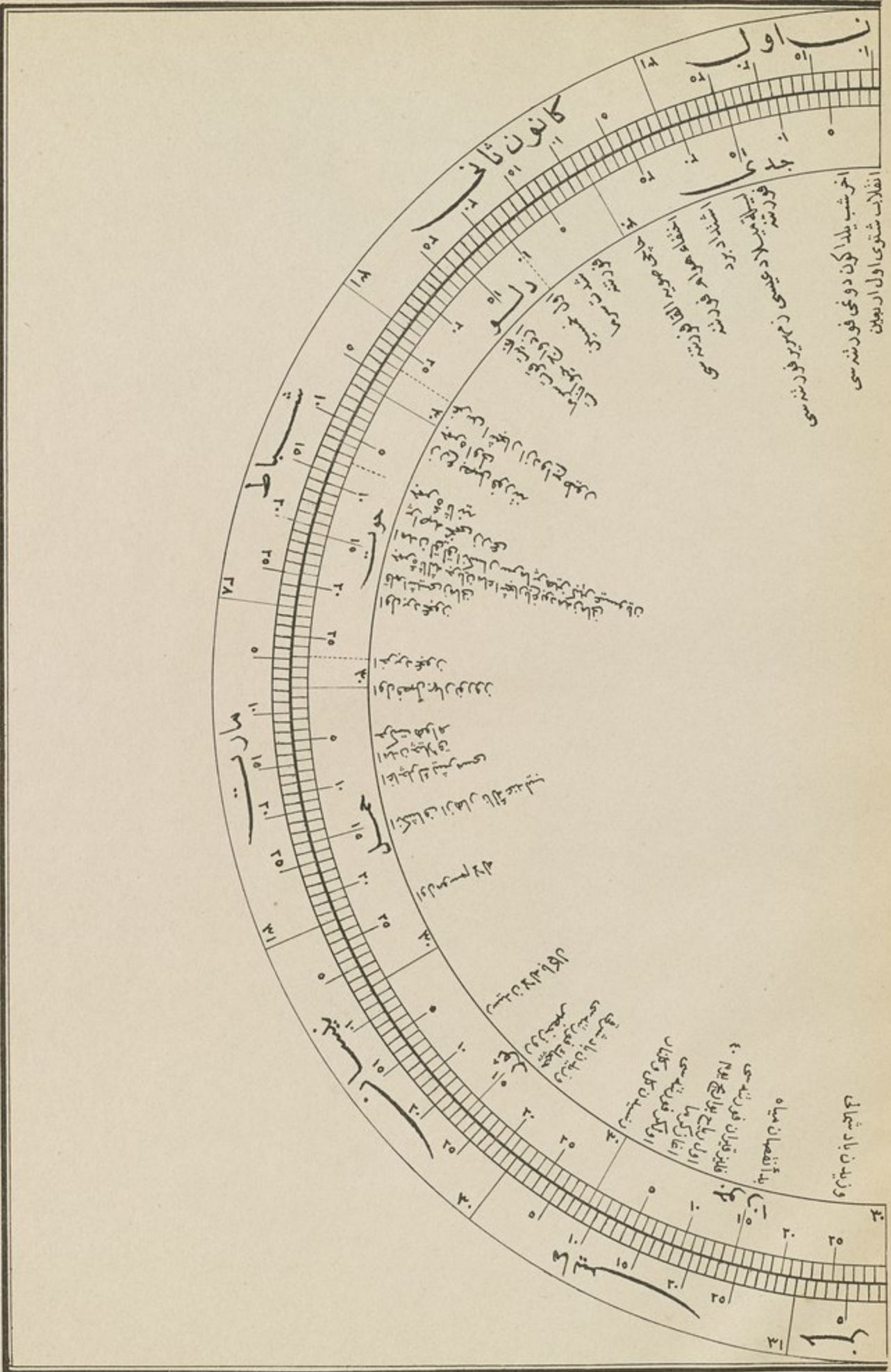

افلاب شتوی اول اربیلین
آخر شب یلدا کون دوخی فولجنته سی

وزید ن بان شمالی

Library of



Princeton University.

Presented by

THE CARNEGIE FOUNDATION

Princeton University Library



32101 073505271

